

SAMSUNG

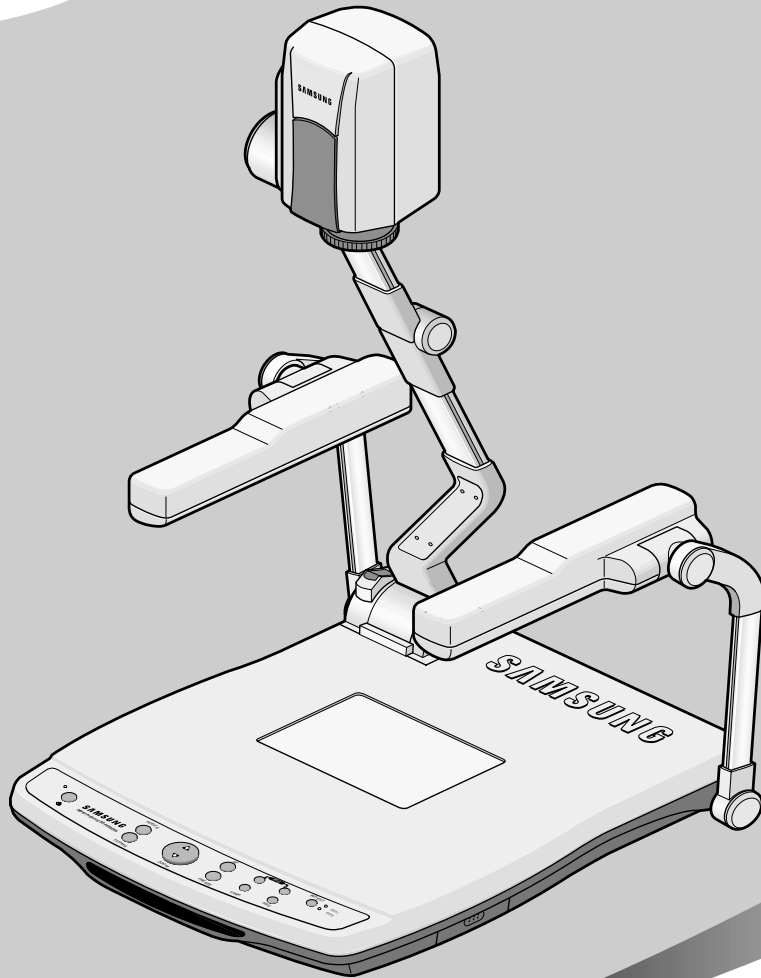

HIGH RESOLUTION DIGITAL PRESENTER

**RS-232C REFERENCE**

# SDP Series

SDP900DXA

SDP950DXA/STA

SDP990DXA

Before attempting to operate this product, Please read the instructions carefully.

[www.samsungpresenter.com](http://www.samsungpresenter.com)

# RS232C PC-side FlowChart

- BaudRate: 9600bps
- Parity Bit: No Parity
- Stop Bit Length: 1-bit
- Character Length: 8-bit
- Start Code: 0xB0
- Stop Code: 0xBF
- Command Code: 4-byte

**(Note1 2nd Rx data == 0x80)**

What the 2nd-Rx-data ("ACK data") is not 0x80 means that the system is doing other operation. (Check up page 6)

With the command "Message-Status", you can check up current status of the system and send the user command. (AWC, etc)

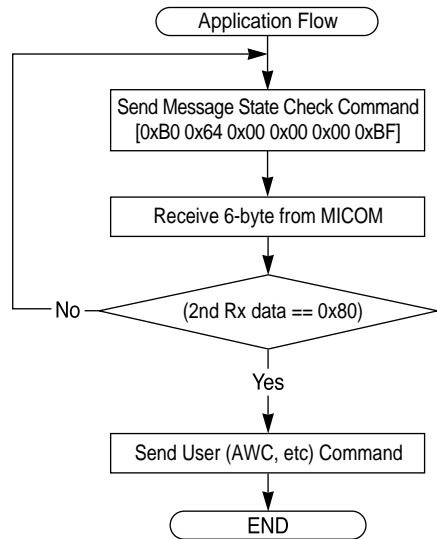
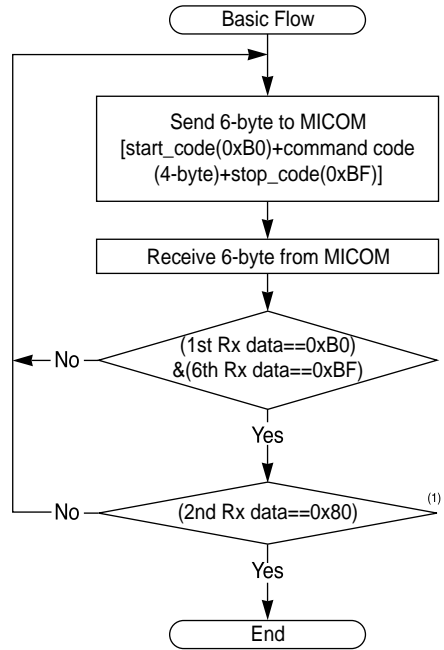

## RS232C Cable Connection

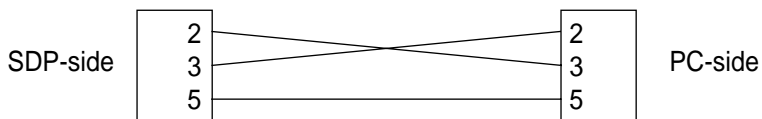

## RS232C Command Code

Command	PC Transmit Data to MICOM				PC Receive Data from MICOM				Remark
	1st	2nd	3rd	4th	1st	2nd	3rd	4th	
AWC	0 x 01	0 x 00	0 x 05	0 x 00	0 x 01	<u>"ACK data"</u>	0 x 05	0 x 00	
AF	0 x 02	0 x 00	0 x 05	0 x 00	0 x 02	<u>"ACK data"</u>	0 x 05	0 x 00	
Upper Lamp	0 x 03	0 x 00	0 x 05	0 x 00	0 x 03	<u>"ACK data"</u>	0 x 05	0 x 00	
Lower Lamp		0 x 00	0 x 08	0 x 00		<u>"ACK data"</u>	0 x 08	0 x 00	
Lamp OFF		0 x 00	0 x 0A	0 x 00		<u>"ACK data"</u>	0 x 0A	0 x 00	
Internal	0 x 04	0 x 00	0 x 05	0 x 00	0 x 04	<u>"ACK data"</u>	0 x 05	0 x 00	
External 1		0 x 00	0 x 08	0 x 00		<u>"ACK data"</u>	0 x 08	0 x 00	
External 2		0 x 00	0 x 0A	0 x 00		<u>"ACK data"</u>		0 x 00	
Positive	0 x 05	0 x 00	0 x 05	0 x 00	0 x 05	<u>"ACK data"</u>	0 x 05	0 x 00	
Negative		0 x 00	0 x 0A	0 x 00		<u>"ACK data"</u>	0 x 0A	0 x 00	
NTSC	0 x 08	0 x 00	0 x 05	0 x 00	0 x 08	<u>"ACK data"</u>	0 x 05	0 x 00	
PAL		0 x 00	0 x 0A	0 x 00		<u>"ACK data"</u>	0 x 0A	0 x 00	
Aperture ON	0 x 09	0 x 00	0 x 05	0 x 00	0 x 09	<u>"ACK data"</u>	0 x 05	0 x 00	
Aperture OFF		0 x 00	0 x 0A	0 x 00		<u>"ACK data"</u>	0 x 0A	0 x 00	
Power ON	0 x 0F	0 x 00	0 x 05	0 x 00	0 x 0F	<u>"ACK data"</u>	0 x 05	0 x 00	
Power OFF		0 x 00	0 x 0A	0 x 00		<u>"ACK data"</u>	0 x 0A	0 x 00	
Rotate OFF	0 x 11	0 x 00	0 x 05	0 x 00	0 x 11	<u>"ACK data"</u>	0 x 05	0 x 00	
Rotate 90°		0 x 00	0 x 08	0 x 00		<u>"ACK data"</u>	0 x 08	0 x 00	
Rotate 180°		0 x 00	0 x 0A	0 x 00		<u>"ACK data"</u>	0 x 0A	0 x 00	
Rotate 360°		0 x 00	0 x 0D	0 x 00		<u>"ACK data"</u>	0 x 0D	0 x 00	

## RS232C Command Code

Command	PC Transmit Data to MICOM				PC Receive Data from MICOM				Remark
	1st	2nd	3rd	4th	1st	2nd	3rd	4th	
Freeze ON	0 x 12	0 x 00	0 x 05	0 x 00	0 x 12	"ACK data"	0 x 05	0 x 00	
Freeze OFF		0 x 00	0 x 0A	0 x 00		"ACK data"	0 x 0A	0 x 00	
Image Save	0 x 13	0 x 00	Number	0 x 00	0 x 13	"ACK data"	Number	0 x 00	Range:"1~8"
Image Recall	0 x 14	0 x 00	Number	0 x 00	0 x 14	"ACK data"	Number	0 x 00	Range:"1~8"
<sup>1)</sup> Image Divide	0 x 15	0 x 00	Number	0 x 00	0 x 15	"ACK data"	Number	0 x 00	Range:"1~9"
Image Shift	0 x 16	0 x 00	0 x 05	0 x 00	0 x 16	"ACK data"	0 x 05	0 x 00	
Preset Save	0 x 17	0 x 00	Number	0 x 00	0 x 17	"ACK data"	Number	0 x 00	Range:"1~4"
Preset Exe	0 x 18	0 x 00	Number	0 x 00	0 x 18	"ACK data"	Number	0 x 00	
Recall, divide, 3x3 multi-screen Cancel	0 x 1F	0 x 00	0 x 05	0 x 00	0 x 1F	"ACK data"	0 x 05	0 x 00	
Iris Up	0 x 21	0 x 00	0 x 05	0 x 00	0 x 21	"ACK data"	0 x 05	0 x 00	
Iris Down		0 x 00	0 x 0A	0 x 00		"ACK data"	0 x 0A	0 x 00	
Red Up	0 x 23	0 x 00	0 x 05	0 x 00	0 x 23	"ACK data"	0 x 05	0 x 00	
Red Down		0 x 00	0 x 0A	0 x 00		"ACK data"	0 x 0A	0 x 00	
Blue Up	0 x 24	0 x 00	0 x 05	0 x 00	0 x 24	"ACK data"	0 x 05	0 x 00	
Blue Down		0 x 00	0 x 0A	0 x 00		"ACK data"	0 x 0A	0 x 00	

**[Note 1]** Transmitting number "9" in image divide command, the system executes 3X3 multi-screen mode.

## RS232C Command Code

Command	PC Transmit Data to MICOM				PC Receive Data from MICOM				Remark
	1st	2nd	3rd	4th	1st	2nd	3rd	4th	
Focus Far	0 x 25	0 x 00	0 x 05	0 x 00	0 x 25	<u>"ACK data"</u>	0 x 05	0 x 00	
Focus Near		0 x 00	0 x 0A	0 x 00		<u>"ACK data"</u>	0 x 0A	0 x 00	
Zoom Tele	0 x 26	0 x 00	0 x 05	0 x 00	0 x 26	<u>"ACK data"</u>	0 x 05	0 x 00	
Zoom Wide		0 x 00	0 x 0A	0 x 00		<u>"ACK data"</u>	0 x 0A	0 x 00	
Iris Target	0 x 41	0 x 00	0 x 00	<u>"data"</u>	0 x 41	<u>"ACK data"</u>	0 x 00	<u>"data"</u>	Range: "1~120"
Red Target	0 x 43	0 x 00	0 x 00	<u>"data"</u>	0 x 43	<u>"ACK data"</u>	0 x 00	<u>"data"</u>	Range: "1~200"
Blue Target	0 x 44	0 x 00	0 x 00	<u>"data"</u>	0 x 44	<u>"ACK data"</u>	0 x 00	<u>"data"</u>	Range: "1~200"
Focus Target	0 x 45	0 x 00	<u>"MSB data"</u>	<u>"LSB data"</u>	0 x 45	<u>"ACK data"</u>	<u>"MSB data"</u>	<u>"LSB data"</u>	<sup>(1)</sup> Range: "0~2225"
Zoom Target	0 x 46	0 x 00	<u>"MSB data"</u>	<u>"LSB data"</u>	0 x 46	<u>"ACK data"</u>	<u>"MSB data"</u>	<u>"LSB data"</u>	Range: "0~1812"
Focus/Zoom concurrent Target	0 x 47	0 x 05	<u>"zoom MSB"</u>	<u>"zoom LSB"</u>	0 x 47	<u>"ACK data"</u>	<u>"zoom MSB"</u>	<u>"zoom LSB"</u>	<sup>(1)</sup> Focus: "0~2225"
		0 x 0A	<u>"focus MSB"</u>	<u>"focus LSB"</u>		<u>"ACK data"</u>	<u>"focus MSB"</u>	<u>"focus LSB"</u>	
<sup>2)</sup> Drive Stop	0 x 2F	0 x 00	0 x 05	0 x 00	0 x 2D	<u>"ACK data"</u>	0 x 05	0 x 00	

**[Note 1]** Depending of the zoom amount, the range of focus data will be changed. You can figure it out to see page 4. ("Focus-Status[Max]", "Focus-Status[Min]")

**[Note 2]** Above 10 Command (Iris up/down ,Red up/down, Blue up/down, Focus far/near, Zoom tele/wide) will go to all the way once you execute it.

"Drive Stop" can stop those command in certain point that you want.

## RS232C Command Code

Command	PC Transmit Data to MICOM				PC Receive Data from MICOM				Remark
	1st	2nd	3rd	4th	1st	2nd	3rd	4th	
Set-Status(Normal)	0 x 61	0 x 00	0 x 00	0 x 00	0 x 61	"ACK data"	Status(MSB)	Status(LSB)	Bit definition of Status represents Page 5, 6, 7
Set-Status(Digital)	0 x 62	0 x 00	0 x 00	0 x 00	0 x 62	"ACK data"	Status(MSB)	Status(LSB)	
Message-Status	0 x 64	0 x 00	0 x 00	0 x 00	0 x 64	"ACK data"	Status(MSB)	Status(LSB)	
Iris-Status	0 x 65	0 x 00	0 x 00	0 x 00	0 x 65	"ACK data"	0 x 00	Status	Range:"1-120"
Red-Status	0 x 67	0 x 00	0 x 00	0 x 00	0 x 67	"ACK data"	0 x 00	Status	Range:"1-200"
Blue-Status	0 x 68	0 x 00	0 x 00	0 x 00	0 x 68	"ACK data"	0 x 00	Status	Range:"1-200"
Zoom-Status	0 x 69	0 x 00	0 x 00	0 x 00	0 x 69	"ACK data"	Status(MSB)	Status(LSB)	Range:"0-1904"
Focus-Status	0 x 6A	0 x 00	0 x 00	0 x 00	0 x 6A	"ACK data"	Status(MSB)	Status(LSB)	Range:"0-2225"
<sup>(1)</sup> Focus-Status(Max)	0 x 6B	0 x 00	0 x 05	0 x 00	0 x 6B	"ACK data"	Status(MSB)	Status(LSB)	Range:"648-2225"
<sup>(1)</sup> Focus-Status(Min)		0 x 00	0 x 0A	0 x 00		"ACK data"	Status(MSB)	Status(LSB)	Range:"0-1383"

**[Note 1]** This command returns focus maximum/minimum data at current zoom position.

## RS232C COMMAND CODE

### ■ Bit Definition of "ACK data"

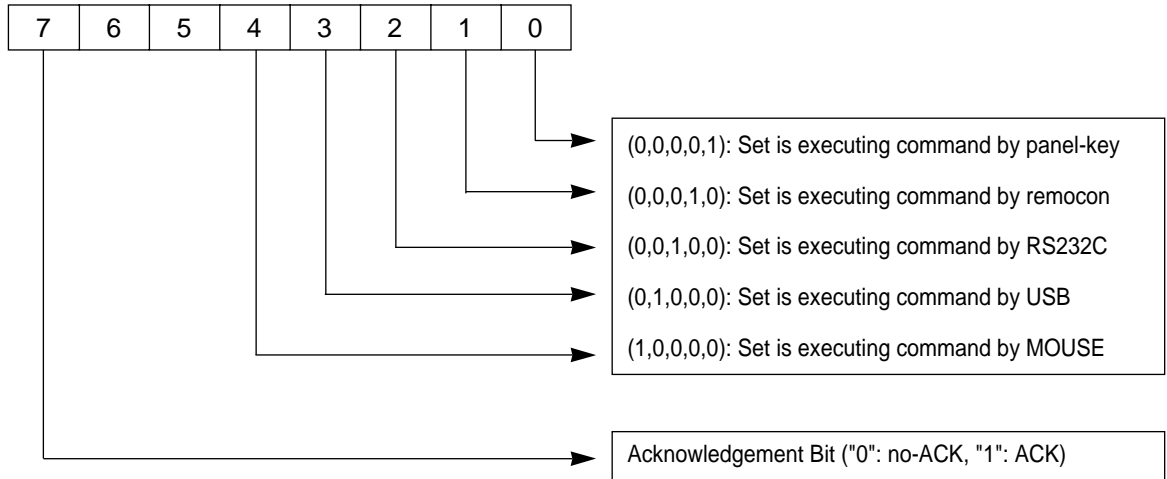

### ■ Status Bit Definition by Message-Status Command

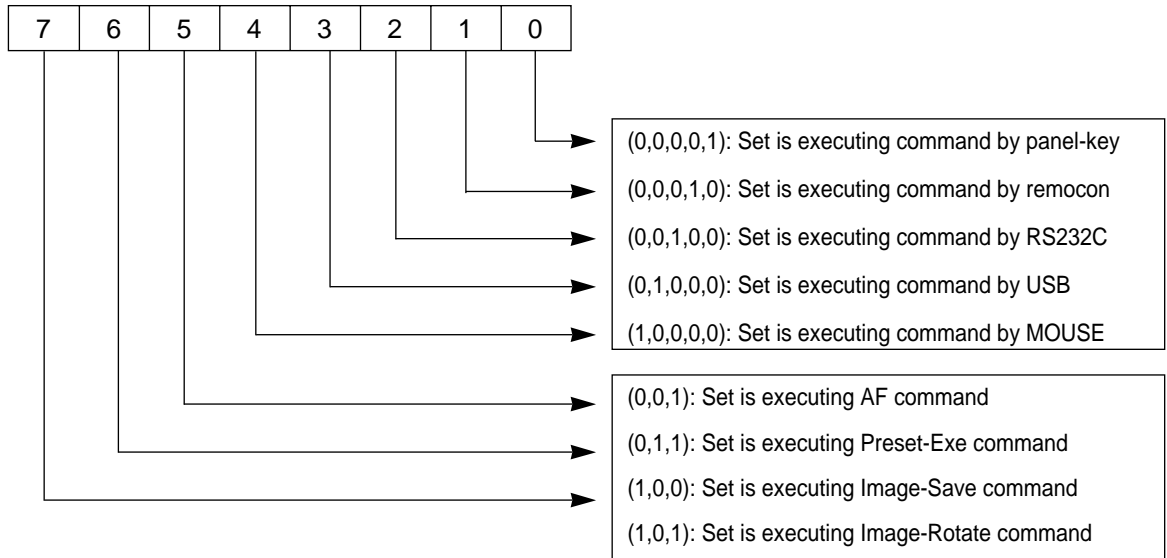

## RS232C Command Code

### ■ Status Bit Definition by Set-Status Command

#### - LSB 8bit

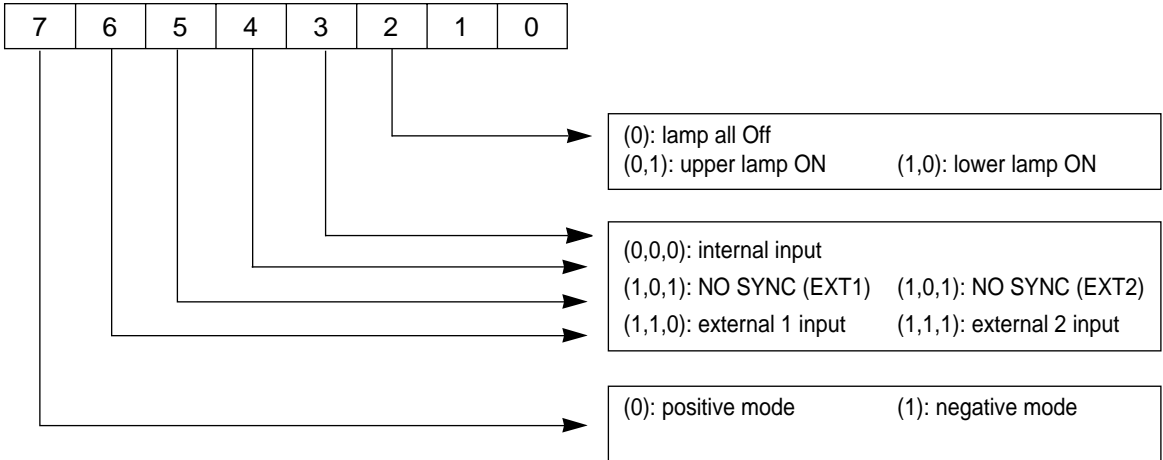

#### - MSB 8bit

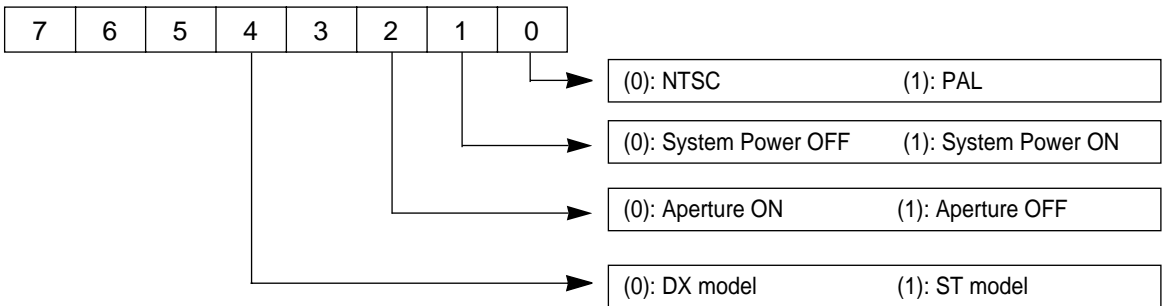

# RS232C COMMAND CODE

## ■ Status Bit Definition by Set-Status(Digital) Command

### - LSB 8bit

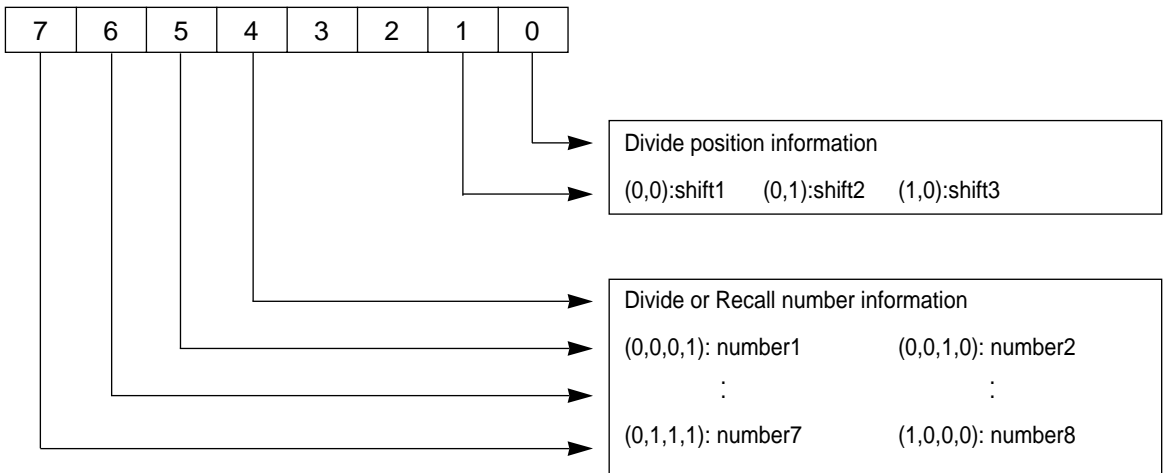

### - MSB 8bit

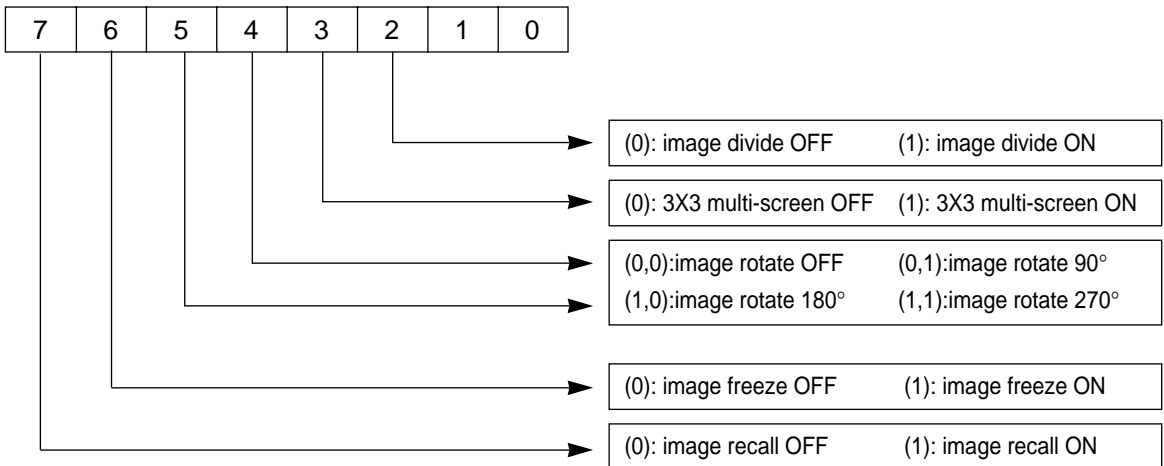

**MEMO**

**MEMO**



## **SAMSUNG TECHWIN CO., LTD**

---

■ **HEAD OFFICE: SAMSUNG TECHWIN CO., LTD**

145-3 Sangdaewon 1-Dong, Jungwon-Gu, Sunnam,  
Kyungki-Do, Korea 462-703  
TEL : 82-31-740-8137~8141  
FAX : 82-31-740-8145

■ **U.S.A OFFICE: SAMSUNG OPTO-ELECTRONICS AMERICA, INC.**

40 Seaview Drive, Secaucus NJ 07094, U.S.A  
TEL : 201-902-0347  
FAX : 201-902-0429

■ **SAMSUNG TECHWIN MOSCOW OFFICE**

LENNINGRADSKY PR-KT, 37-A. KORP.14  
RUSSIA, 125167, MOSCOW  
TEL: +7-095-258-9296, 9298      FAX: +7-095-258-9297

■ **SAMSUNG OPTO-ELECTRONICS UK LTD (SOUK)**

Samsung House, 1000 Hillswood Drive Hillswood Business  
Park Chertsey Surrey KT16OPS  
TEL : 44-(0)1932-45-5308      FAX : 44-(0)1932-45-5325

■ **TIANJIN SAMSUNG OPTO-ELECTRONICS CO.,LTD (TSOE)**

7 Pingchang Rd, Nankai Dist, Tianjin, P.R China Post Code : 300190  
TEL : 86-22-2761-9698      FAX : 86-22-2761-6514