

Notices

Reproduction or reprinting, without permission, of this manual or any part thereof is prohibited.

The contents of this manual are subject to change without prior notice.

Every effort has been made to ensure that this manual is complete and correct. However, should any questionable points, mistakes, etc., come to your attention, please inform the vendor.

Please be advised in advance that this company will assume no responsibility for losses, etc., resulting from the operation of this product, regardless of the preceding clauses.

Also, in the event that this manual has pages out of order, missing pages or other problems with the printing or binding, it will be replaced free of charge within one year after purchase. Contact technical support for details.

Discarding this product

This product must be disposed of as industrial waste, in accordance with the relevant laws and regulations.

Special Instructions

This manual includes descriptions of required components in addition to descriptions of the product itself. For details on required components, see "4.7 Required components (Other vendor)."

Disclaimers

Hitachi Software Engineering Co., Ltd. assumes no liability and makes no warranty, either express or implicit, regarding the contents of this user's guide.

Also, the company makes no warranty as to the product's suitability, merchantability or fitness for a particular intended use.

All products of Hitachi Software Engineering Co., Ltd., described in this user's guide are presently for sale or are site-licensed.

Users who purchased the aforesaid product(s) will bear the costs of all required services, repairs, and damages resulting from defects in this product, and will bear the costs of direct or indirect damages (including the loss of profits or required information) that resulted from the product defects.

Moreover, Hitachi Software Engineering Co., Ltd. retains the right to revise this user's guide and to modify the contents thereof, without any obligation to notify anyone.

Product Assurance Provisions

This product is limited to use in the country where the user bought this product.

For warranty details, refer to "**4.8 Provisions of Product Warranty**" of this user's guide.

This 1st edition of the User's Guide (PXD-EU091015) is for the following products:

AH00235: PX-DUO-50P Digitiser

AH00246: Additional Function Button

AH00232: PX-DUO-65P Digitiser

AH00180: FX/PX-DUO Electronic Pen

Windows is registered trademarks of Microsoft Corporation (U.S.) and in other countries.

Other trademarks and product names are trademarks and/or registered trademarks of their respective holders.

User's Guide Creation Dates

October 2009, First Edition

PXD-EU091015

Introduction

Thank you very much for purchasing HitachiSoft's StarBoard PX-DUO-50P/65P (henceforth referred to as "StarBoard").

This User's Guide has been created for people who already have a working knowledge of personal computers (henceforth referred to as "PC").

Please make sure that you understand the contents of this User's Guide and use the software correctly.

We hope that you make the most of this product.

If you have technical questions of Plasma Display, please contact the Plasma Display support centre, which is mentioned in Plasma Display Operation Manual. Other questions, please contact your dealer.

Safe Handling

Markings and Symbols

Various markings and symbols are used in this user's guide and on this product, to ensure the safe and correct use of this product and to prevent personal injury and property damage. These symbols and their meanings are as explained below. Understand the information well before reading the body of the user's guide.



This is a Safety Warning symbol. This symbol will appear to raise the attention of the user to existing risks that may cause harm to people. To avoid any chances of injuries or possibly death, **DO NOT IGNORE** the safety instructions that follow this symbol.



WARNINGS

This warning will appear where there exists a risk of death or fatal injuries.



CAUTIONS

This warning will appear where there exists a risk of moderate or light injuries.

NOTICE

This warning will appear where there exists a risk of damage to property.



This symbol draws attention to cautions (including warnings).







This symbol indicates something prohibited.







This symbol indicates something that must be done.



Safety Precautions Required Precautions

(1) Precautions for Use



 WARNING	
	<p>Do not alter this product. Do not make any adjustments, repairs or modifications not given in this User's Guide. Electric shock or other injury will result.</p>
	<p>Do not open or remove the rear cover, cabinet, or cover to this product. Failure to comply may lead to personal injury or damage to the product. Refer internal inspections, adjustments, and repairs to your dealer or support centre.</p>
	<p>Do not place objects on top of this product. If a foreign object falls on top of or inside this product, it may lead to personal injury or damage to the product.</p>





NOTICE	
	<p>Do not use a USB cable other than the one supplied. Use of a USB cable other than the one supplied may result in malfunction.</p>
	<p>Do not place heavy objects on, pull on, or subject the USB cable to excess heat. Failure to comply may result damage to the USB cable.</p>
	<p>Always grasp the plug of the USB cable when connecting or disconnecting. Pulling on the USB cable may result in scratching or damage to the cable.</p>
	<p>Always lock the casters with stoppers on the front side after installing this product. Failure to lock the casters may allow the product to move or slide.</p>



(2) Dealing with Trouble



 CAUTION	
	<p>What to do in case of emission of smoke, strange odor, or strange noise.</p> <p>If an abnormal condition such as emission of smoke, strange odor, or strange noise happens to occur for some reason, immediately disconnect the product's USB cable from the PC.</p> <p>Confirm that the smoke or strange odor is no longer being emitted and contact a support centre to request repairs.</p> <p>Continued operation without repair may result in fire.</p>
	<p>What to do if the product breaks or the USB cable is damaged.</p> <p>If this product breaks or the USB cable becomes damaged for some reason, immediately disconnect the USB cable from the PC and contact a support centre.</p> <p>Continued operation without repair may result in emission of a strange odor or smoke.</p>

(3) Precautions Regarding Handling





 WARNING	
	<p>Do not touch the main unit during thunder and lightning storms.</p> <p>Electric shock will result.</p>

 CAUTION	
	<p>Do not hang from or climb onto the main unit.</p> <p>This product may fall, tip over or become damaged, possibly resulting in injury.</p> <p>Take special care for children around this product.</p>
	<p>Do not place a heavy object on the main unit.</p> <p>Do not place a heavy object on this product.</p> <p>The object may become unbalanced and fall, possibly resulting in injury.</p>
	<p>Do not expose this product to water or chemicals.</p> <p>Do not place this product in a location exposed to dripping water, and do not place containers with water or chemicals on or near this product.</p> <p>If water or chemicals enter this product, fire or electric shock might result.</p>



 CAUTION	
	<p>Do not mix new batteries with old batteries, and do not use other than the specified batteries. Improper use may cause the batteries to rupture or leak, possibly resulting in fire, injury or corruption of the surroundings.</p>





NOTICE	
	<p>Disconnect the USB cable during extended periods of non-use. For safety reasons, disconnect the USB cable if the product is not going to be used for an extended period of time. Failure to comply may result in malfunction.</p>
	<p>Arrange the connecting cables properly. Do not pinch the cables against a wall, or excessively bend, pull on or twist the cables. This may expose, short or sever the core wires, possibly resulting in fire or electric shock.</p>







(4) Precautions Regarding Moving the Product

 CAUTION	
	<p>Always use two or more people to move this product. This product is a very large and heavy precision instrument. Always use two or more people and take great care when moving this product.</p>
	<p>Always disconnect the USB cable from the PC when moving this product. Failure to comply may result in damage to the USB cable and/or the product itself.</p>
	<p>Do not subject to shock of impact. This product is a precision instrument. Excessive shock of impact may hinder further operation. Take extreme care when moving this product.</p>
	<p>Always remove the Digitiser before removing or altering the height of the plasma display. Failure to comply may result in personal injury or damage to the Digitiser unit.</p>

(5) Precautions Regarding Setup Environment

 WARNING	
	<p>Wall mounting and ceiling mounting work should be performed by a construction specialist. Incomplete work may result in death or injury. Be sure to use the specified mounting unit.</p>
	<p>Do not place in a location with flammable or corrosive gas. Placing this product in a location where there is flammable or corrosive gas may result in fire or damage to this product. There is a particular danger of explosion in the case of flammable gas. Do not place in a location with flammable or corrosive gas.</p>

 CAUTION	
	<p>Improper assembly might cause the product to fall over or result in other accidents. There is risk of injury if the product falls over. Be sure to securely tighten the screws for each part.</p>
	<p>Do not place in locations subject to excess moisture, dust, smoke, or steam. Placement in a location such as next to a kitchen or a humidifier may result in fire or damage to this product.</p>
	<p>Do not touch internally mounted parts. Directly touching internally mounted parts inside this product may result in personal injury or damage to this product.</p>
	<p>Do not use this product near water. If water somehow gets inside this product, immediately disconnect the USB cable and contact a support centre. Continued use may result in fire or damage to this product.</p>

NOTICE	
	<p>Regarding the setup environment Set up this product on a level floor surface with a weight bearing capacity of 150 kg/m² or more, and which is made of floor materials that will not deform or become depressed due to movement by casters.</p>
	<p>Do not use this product in locations subject to high temperature or high humidity. This product's usage environment conditions: Temperature: 5°C – 35°C Humidity: 20%RH – 80%RH (no condensation)</p>
	<p>Do not set up in locations subject to vibration and/or shock of impact. Vibration and/or shock of impact may harm internal components of this product, resulting in damage to it. Do not set up this product in a location subject to vibration or shock of impact.</p>
	<p>Do not set up this product near a high-voltage line or power source. If this product is set up near high-voltage lines or power sources, it might receive interference.</p>
	<p>Do not set up in a location subject to direct sunlight or near a heater. Failure to comply may result in deformation of or damage to this product.</p>
	<p>Do not lay the Digitiser flat and then mount the plasma display. The Digitiser will receive the weight of the plasma display, possibly resulting in product failure.</p>
	<p>Be careful about interference between equipment. The plasma display might cause noise to enter the image or audio from video decks, radios or other equipment, or cause this equipment to malfunction. (If these problems occur, locate the equipment a sufficient distance away from the display unit.)</p>

(6) Precautions Regarding Disposal

NOTICE	
	<p>At time of disposal, handle this product as industrial waste according to all applicable laws and regulations. When disposing of this product, the user should follow all laws and regulations of the locality in which it is being used.</p>

(7) Contents of Warnings in this Manual

 WARNING	Page
Please follow the stand's manual when you assemble the mobile stand. When not following stand's manual, it may lead to personal injury or damage to the product.	P.2-1
Please follow the stand's manual when you setup the plasma display. When not following stand's manual, it may lead to personal injury or damage to the product.	P.2-2
Be sure to perform earth work. Be sure to properly connect the power cable earth. If the earth is not connected, electric shock or fire might result.	P.2-4

 CAUTION	Page
Tighten the screws securely. Improper assembly might cause the digitiser to fall, possibly resulting in injury, or the impact of the fall might cause product failure.	P.2-2
Always perform the work with two or more people. Otherwise, the equipment might fall, possibly resulting in injury, or the impact might cause product failure.	P.2-2

 CAUTION	Page
Be careful to insert the batteries correctly. When inserting the batteries, be careful not to mistake the polarity indications (+ and - directions), and do not use other than the specified type of batteries. Improper use may cause heating or product failure.	P.2-7
Be sure to insulate the batteries during disposal. When disposing of the batteries, first insulate the anodes and cathodes using cellophane tape, etc. If the batteries are disposed of without proper insulation, the batteries might short and become hot, rupture or ignite, possible resulting in injury or fire. In addition, be sure to abide by local laws and regulations when disposing of the batteries.	P.2-7
Do not strike the board forcefully with the stylus pen, bend it, or apply an excessive load to it. Failure to comply may result in damage to the stylus pen or personal injury.	P.3-6
Before cleaning StarBoard, be sure to disconnect the power cable and the USB cable. Electric shock or damage to the product will result.	P.4-9

NOTICE	Page
Make cable connection after turning off the power. Connecting cables without turning off the power may lead to damage to equipment.	P.2-4
Do not unplug and re-plug in the USB cable. Unplugging and re-plugging the USB cable after turning on the StarBoard may cause the Digitiser to no longer function normally.	P.2-4
Use an input tool with a thickness of least 7 mm. When inputting to this product, use a tool that is at least 7 mm. If a pen or similar tool with a thickness of less than 7 mm is used, the input will be unstable. Also, do not use tools with a sharp tip, such as a ballpoint pen. If such a tool is used incorrectly, it could damage the surface of the board.	P.3-4
Keep the stylus pen in the pen tray when not in use. If you leave it on the reflective tape, it might cause a sensor error or incorrect detection.	P.3-6

Contents

1. About the StarBoard.....	1-1
1.1 Preparations before Use.....	1-1
1.1.1 Product Outline.....	1-1
1.1.2 Features.....	1-1
1.2 Parts and Accessories Check	1-2
1.2.1 PX-DUO-50P/65P Digitiser (HitachiSoft Product)	1-2
1.2.2 Mobile Stand (Other vendor)	1-4
1.2.3 Plasma Display (Other vendor)	1-4
1.3 Name of Each Part	1-5
1.3.1 Names of Parts on the Front of the Product (Configuration example of wall mounting stand).....	1-5
1.3.2 Names of Parts on the Back of the Product.....	1-6
1.3.3 Function Button.....	1-7
1.3.4 Electronic Pen.....	1-8
2. StarBoard Setup.....	2-1
2.1 Assembly and Setup Method	2-1
2.1.1 Assembling the Mobile Stand.....	2-1
2.1.2 Setting Up the Plasma Display.....	2-2
2.1.3 Setting Up the PX-DUO-50P/65P Digitiser.....	2-2
2.1.4 Connecting the StarBoard Cables.....	2-4
2.2 Inserting Batteries into the Electronic Pen	2-7
2.3 StarBoard Software Setup	2-7
3. Using the StarBoard	3-1
3.1 Using the StarBoard	3-1
3.1.1 Starting Up the StarBoard	3-1
3.1.2 Shutting Down the StarBoard.....	3-2
3.1.3 StarBoard Operation Procedure.....	3-3
3.2 How to Use Touch Mode	3-4
3.2.1 Character Input.....	3-4
3.2.2 PC Operations.....	3-5

3.3 How to Use the Electronic Pen	3-7
3.3.1 Using the Electronic Pen	3-7
3.3.2 Electronic Pen Basic Operations	3-8
3.3.3 Customising the Electronic Pen	3-8
4. Appendix.....	4-1
4.1 Troubleshooting	4-1
4.2 Adjust the sensor (for Windows)	4-4
4.2.1 Items to Check Before Making Sensor Adjustments	4-4
4.2.2 Sensor Adjustment Procedure	4-4
4.3 Regularly Auto Sensor Adjustment.....	4-6
4.3.1 Sensor Auto Adjustment Procedure.....	4-6
4.4 Product Specifications.....	4-8
4.4.1 PX-DUO-50P/65P Digitiser Specifications	4-8
4.4.2 Plasma Specifications.....	4-8
4.5 Proper Care and Cleaning	4-9
4.6 Replaceable Parts/Limited Operating Life parts.....	4-9
4.6.1 Replaceable Parts	4-9
4.6.2 Limited Lifespan	4-9
4.7 Required components (Other vendor).....	4-10
4.7.1 Plasma display / Dedicated Setup Unit	4-10
4.7.2 Dedicated Speakers	4-10
4.8 Provisions of Product Warranty.....	4-11

1. About the StarBoard

1.1 Preparations before Use

1.2 Parts and Accessories Check

1.3 Name of Each Part

1. About the StarBoard

1.1 Preparations before Use

This chapter describes the preparations before using the StarBoard.

First-time users should read this chapter carefully before using the StarBoard.

1.1.1 Product Outline

The StarBoard PX-DUO-50P/65P is an extremely convenient plasma display type StarBoard that allows easy operation. Setting up the supplied software in a PC connected to the StarBoard PX-DUO-50P/65P lets you operate the PC using the Electronic pen or your finger, and load characters and figures drawn on the PC screen to the PC in real time.

1.1.2 Features

- Direct write to the PC screen

You can operate the PC on the screen appearing on the plasma display by using the Electronic pen or your finger as a mouse. In addition, dedicated software lets you write characters and figures on the screen, and these characters and figures can be loaded to the PC in real time as digital data for saving, printing, etc.

- Immediate use after PC startup

Simply install the StarBoard Software supplied with the StarBoard in the connected PC, and you can use the StarBoard as soon as the PC is started up.

- Support for PowerPoint presentations

You can write characters and figures on presentation materials created using Microsoft PowerPoint. This further expands the range of expression of your presentations. In addition, teleconferencing linkup is also possible.

- Write to video images

You can write characters and figures on screens showing captured video images. This makes it easy to use video materials for teaching and presentations.

1.2 Parts and Accessories Check

The StarBoard PX-DUO-50P/65P is comprised of the PX-DUO-50P/65P Digitiser, the Mobile stand/Wall mounting unit, and the plasma display. This User's Guide describes setup using the mobile stand. After unpacking, make sure that all of the following parts and accessories are present.

1.2.1 PX-DUO-50P/65P Digitiser (HitachiSoft product)

[1] Parts

No.	Name	Qty.
(1)	PX-DUO-50P/65P Digitiser	1
(2)	Digitiser clamp A	2
(3)	Digitiser clamp B	2
(4)	Pen tray	1
(5)	Digitiser lock screw	8

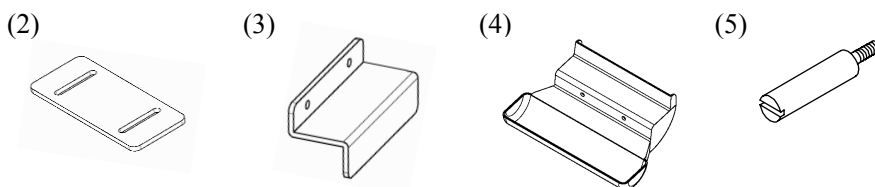
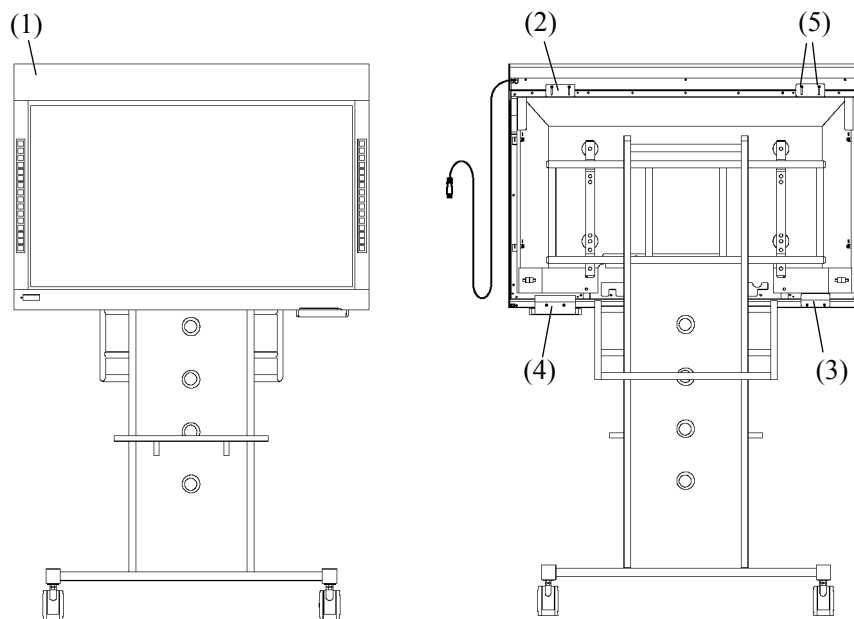

[2] Accessories

No.	Name	Qty.
(1)	RGB cable (3m)	1
(2)	Audio cable (3m)	1
(3)	Stylus pen	2
(4)	Electronic pen	1
(5)	AAA alkaline Battery	1
(6)	Spare pen tip	2
(7)	Starboard Software x.x DVD-ROM (*1)	1
(8)	StarBoard Software x.x Installation Guide (*1)	1
(9)	PX-DUO-50P/65P User's Guide (this manual)	1
(10)	Warranty sheet	1

(*1) The term "x.x." as used in this manual denotes the same version as the software which is included with the accessories.

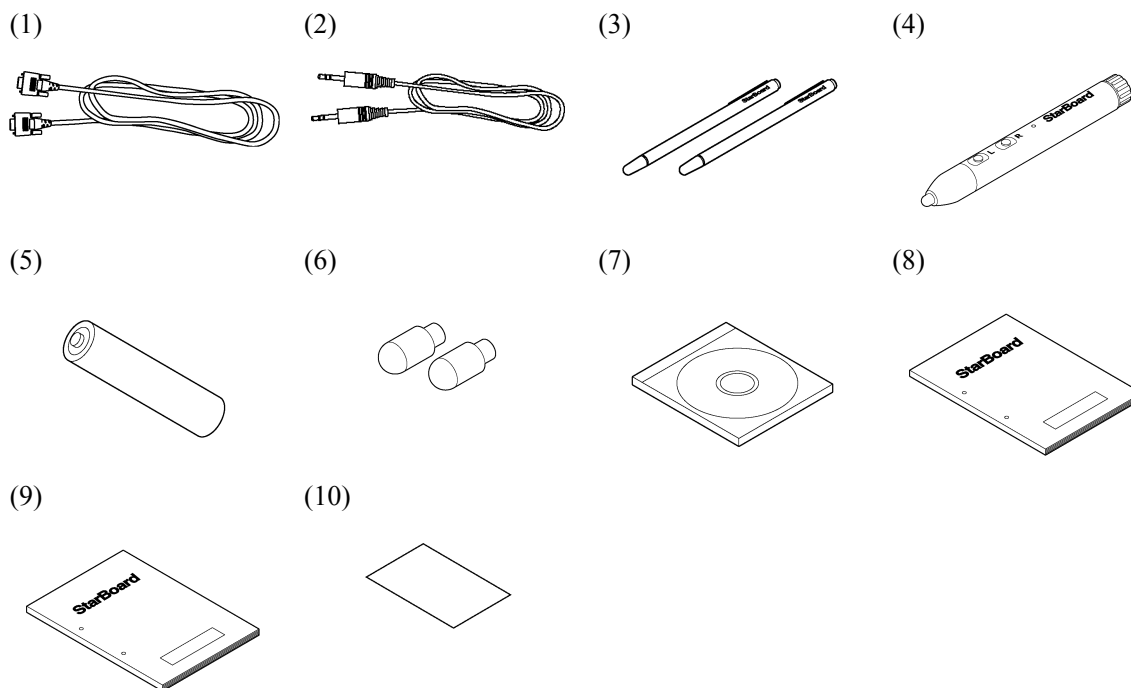

1.2.2 Mobile Stand (Other vendor)

About the parts and accessories of the mobile stand please refer to the operation manual of it.

About the stand

The StarBoard main unit cannot be set up independently. Be sure to set up the StarBoard using the mobile stand or the wall mounting unit specified by Hitachi above. This User's Guide describes setup using the mobile stand.

For details on required components, see "4.7 Required components (Other vendor)."

When using the wall mounting unit, the mounting work must be performed by a specialist, so be sure to contact your dealer or technical support.

1.2.3 Plasma Display (Other vendor)

About the parts and accessories of the plasma display, please refer to the operation manual of it.

1.3 Name of Each Part

1.3.1 Names of Parts on the Front of the Product (Configuration example of Mobile stand)

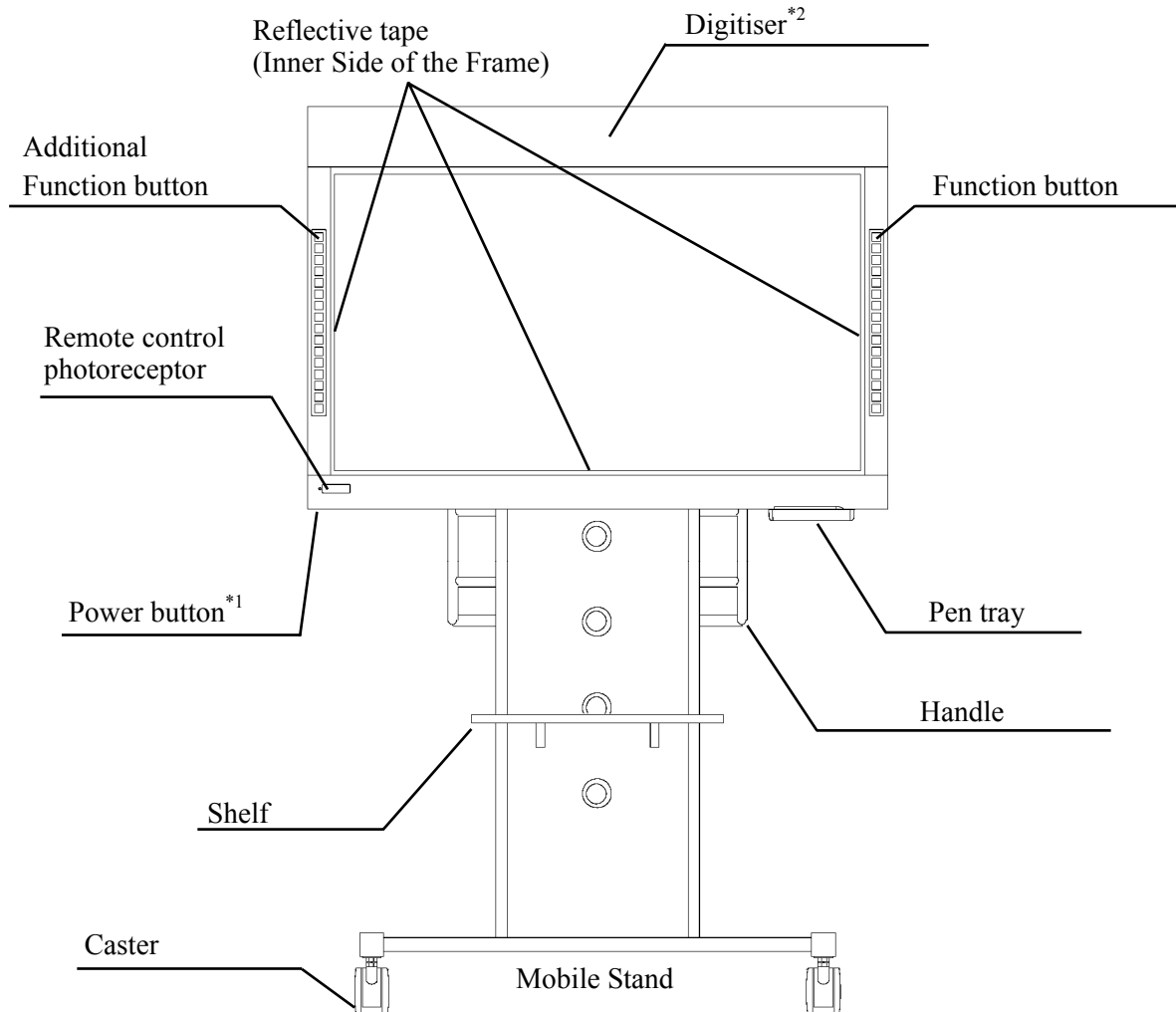

*1 Pressing the power button turns the power on and off.

When the power button on the Plasma display is on, the POWER lamp in the remote control photoreceptor lights green.

When the power is turned off (Standby) with the remote control:

The POWER lamp lights red.

When the power is turned on (Power-on) with the remote control:

The POWER lamp lights green.





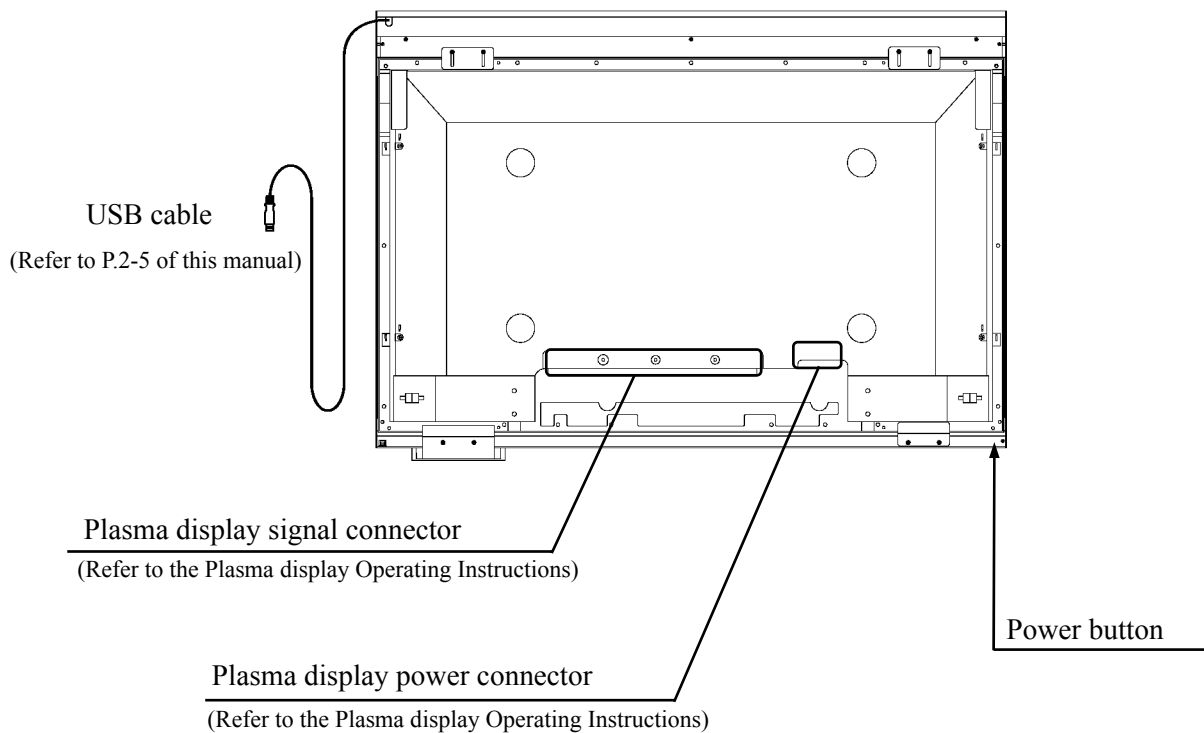









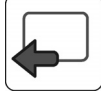

*2 The Digitiser detects the position of the electronic pen or your finger and receives the electronic pen button and switch operation information, and transmits this data to the PC. The Digitiser itself does not have a power button. The Digitiser is turned on and off by plugging in and unplugging the USB cable. Be sure to unplug the USB cable from the PC after using the Digitiser.

1.3.2 Names of Parts on the Back of the Product



1.3.3 Function Button

The function button is provided with shortcut keys for the functions that are frequently used in the StarBoard Software. Use by clicking the middle of the symbol with your finger. With the exception of touch mode/pen mode selection and one-time right click, you can customise the shortcuts with the software. Refer to the online help for details. The default settings are as follows.

Symbol	Description	Symbol	Description
	Select touch mode or pen mode. (*1)		Select Solid Pen (black).
	Select one-time right click. (*1) (*2)		Select Solid Pen (red).
	Hides/displays the StarBoard Software Toolbar.		Select Solid Pen (blue).
	Adds a new blank page.		Select Solid Pen (green).
	Show previous page.		Select Fluorescent Marker Pen.
	Show next page.		Select Eraser.
	Hides/displays the Topic List.		Customisable button 1
	Switch to PC Operation.		Customisable button 2

(*1) These buttons cannot be customised.

(*2) About one-time right click:

- When the one-time right click function button is pressed, the next finger or electronic pen input becomes right-click operational one time only.
- After the function button is pressed, the one-time right click operation is not cancelled until a finger or electronic pen input is made.

(*3) The function buttons on the left and right sides cannot be operated at the same time.

1.3.4 Electronic Pen

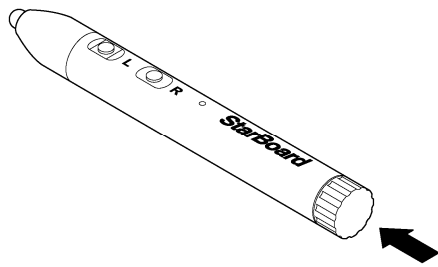

- (1) Battery cover
Open the cover when inserting or replacing the battery. Refer to page 2-7 in this User's Guide for details.

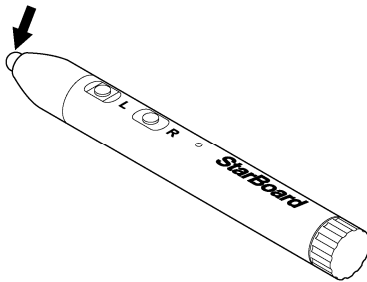

- (2) Pen tip switch
This is assigned the left click function. Refer to page 3-8 in this User's Guide for details.

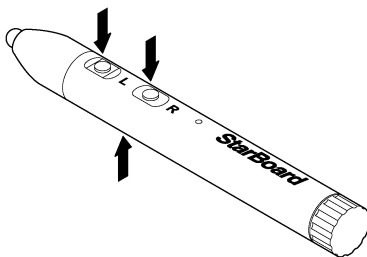

- (3) Side buttons
Operations such as right click and scrolling can be assigned to these buttons. Refer to page 3-8 in this User's Guide for details.

2. StarBoard Setup

2.1 Assembly and Setup Method

2.2 Inserting Batteries into the Electronic Pen

2.3 StarBoard Software Setup

2. StarBoard Setup

2.1 Assembly and Setup Method

Care should be taken for the following items when setting up the StarBoard.

- Select a stable, flat location.
- Do not set up the StarBoard near wireless transmitters, TVs, copying machines, cooling and heating units, or other equipment that may generate electromagnetic waves.
- Avoid setup in dusty locations or locations subject to excessively high or low temperatures and humidity.
- This product is an optical device, so avoid setup in locations exposed to direct sunlight or near sources of intense light. Malfunction might result.
- When two StarBoards are set up next to each other or when multiple StarBoards are set up within the same room, malfunction might result. Contact your dealer or technical support regarding these types of setup.

2.1.1 Assembling the Mobile Stand

Before assembling and setting up the stand, check once again to make sure all the parts are present.

 **WARNING**

Please follow the stand's manual when you assemble the mobile stand.
When not following stand's manual, it may lead to personal injury or damage to the product.

Please see the stand's manual when you assemble.

2.1.2 Setting Up the Plasma Display

Attach the plasma display to the stand assembled in the previous section.

 WARNING
--

Please follow the stand's manual when you setup the plasma display.
--

When not following stand's manual, it may lead to personal injury or damage to the product.

Please see the stand's manual to assemble the plasma display. Perform the assembly work with the stand casters locked.

2.1.3 Setting Up the PX-DUO Series Digitiser

Attach the Digitiser to the stand and the plasma display assembled in the previous sections.

 CAUTION
--

Tighten the screws securely.

Improper assembly might cause the digitiser to fall, possibly resulting in injury, or the impact of the fall might cause product failure.

Always perform the work with two or more people.

Otherwise, the equipment might fall, possibly resulting in injury, or the impact might cause product failure.

Follow the procedure below to assemble the plasma display. Perform the assembly work with the stand casters locked.

- (1) Fit the PX-DUO Series Digitiser over the plasma display from the front.
- (2) Secure the Digitiser clamp A using the Digitiser lock screws.
(Place the rubber cushion on inside-bottom.)
- (3) Secure the Digitiser clamp B using the Digitiser lock screws.
(When the Pen tray is unnecessary, using the Digitiser clamp B.)

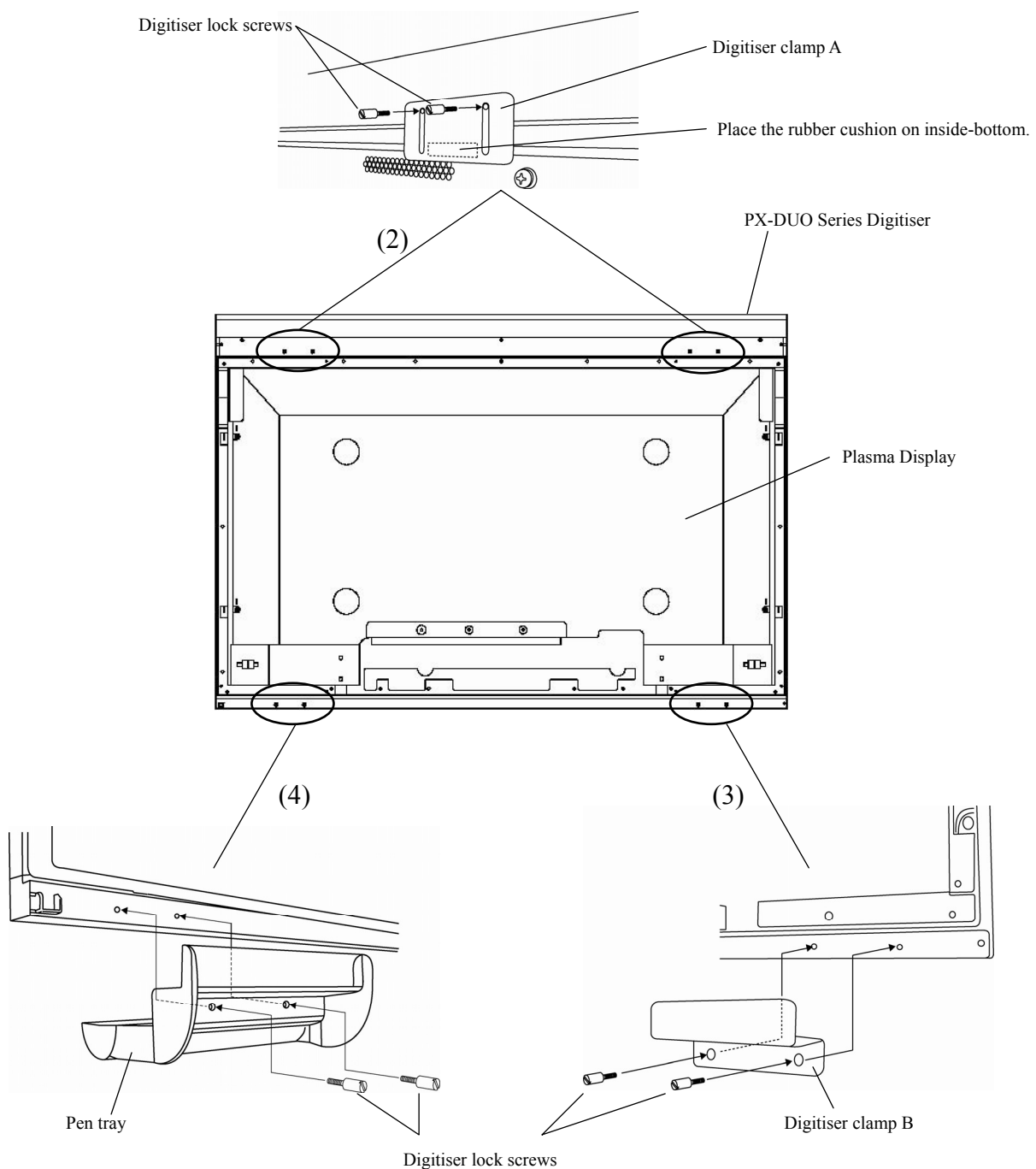

2.1.4 Connecting the StarBoard Cables

Before Connecting Equipment

Install the StarBoard Software on your PC before connecting equipment. Equipment may not function normally if connections are made without first installing the software.

WARNING

Be sure to perform earth work.

Be sure to properly connect the power cable earth. If the earth is not connected, electric shock or fire might result.

NOTICE

Make cable connection after turning off the power.

Connecting cables without turning off the power may lead to damage to equipment.

Do not unplug and re-plug in the USB cable.

Unplugging and re-plugging the USB cable after turning on the StarBoard may cause the Digitiser to no longer function normally.

Follow the procedure below to connect the StarBoard to the PC and the power outlet.

- PX-DUO-50P

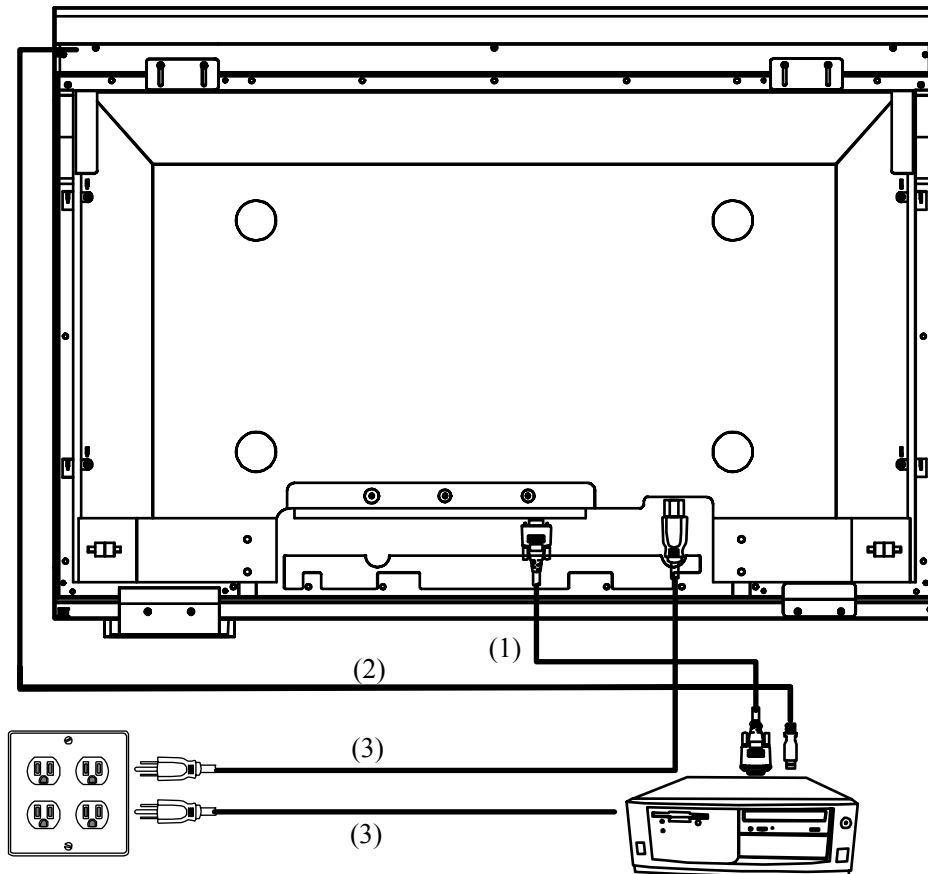

- (1) Connect the RGB cable to the RGB connector of the Plasma display, and then tighten the screws. Connect the other end of the RGB cable to the RGB connector of the PC, and then tighten the screws. (How to connect the cables, refer to the Plasma Display Operation Manual).
- (2) Connect the USB cable to the USB connector of the PC.
- (3) Connect the PC and Plasma display power cables to the power outlet.

- PX-DUO-65P

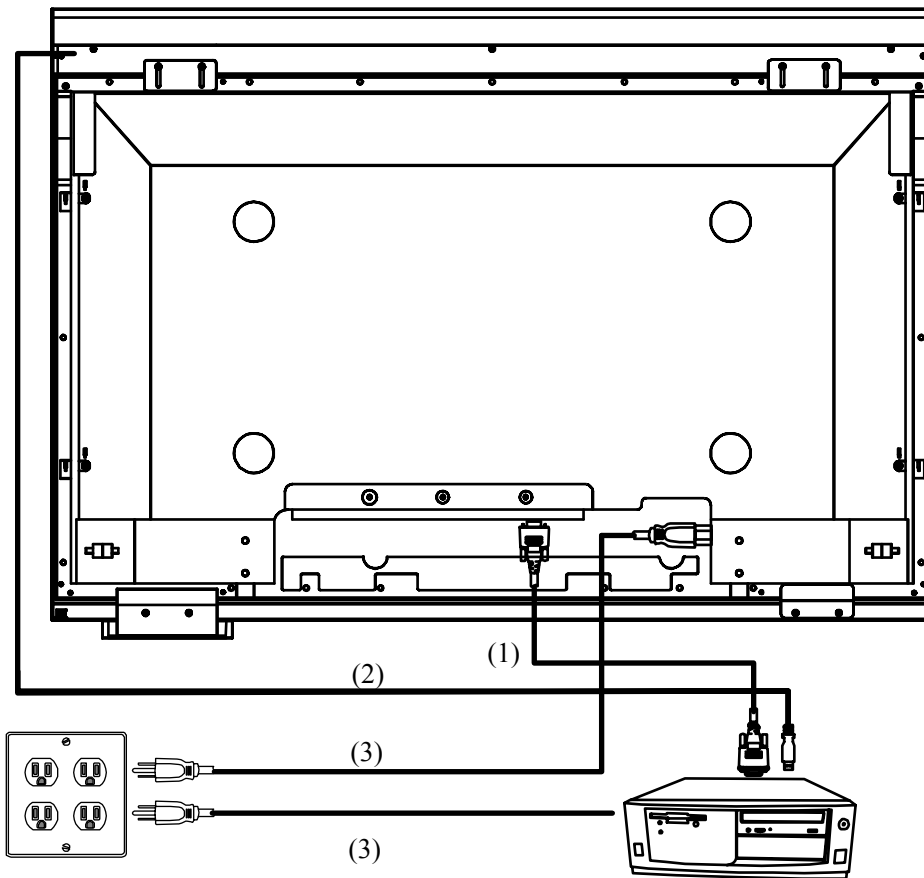

- (1) Connect the RGB cable to the RGB connector of the Plasma display, and then tighten the screws. Connect the other end of the RGB cable to the RGB connector of the PC, and then tighten the screws. (How to connect the cables, refer to the Plasma Display Operation Manual).
- (2) Connect the USB cable to the USB connector of the PC.
- (3) Connect the PC and Plasma display power cables to the power outlet.

2.2 Inserting Batteries into the Electronic Pen

Perform the preparations for using the electronic pen.

 CAUTION
Be sure to install batteries correctly. Do not install batteries with positive and negative terminals reversed, or use batteries other than the type specified. Failure to comply may result in overheating or damage to this product.
Be sure to provide insulation during disposal. Be sure to insulate the positive and negative terminals of the battery using cellophane tape, or similar material when disposing of batteries. Disposing of batteries without insulating them may lead to overheating, bursting, or ignition due to shorting, resulting in personal injury or fire. Furthermore, be sure to follow all local rules and regulations regarding proper battery disposal.

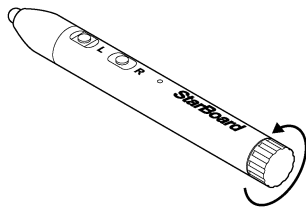

- (1) Open the battery cover by moving it in the direction of the arrow.

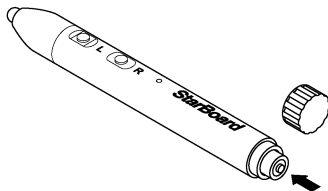

- (2) As shown in the figure, insert the AAA alkaline battery so that the + side faces the outside.

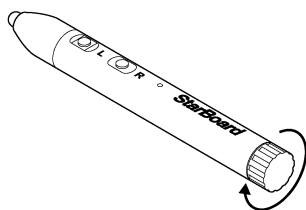

- (3) Close the battery cover by moving it in the direction of the arrow.

2.3 StarBoard Software Setup

For information on how to install StarBoard Software and detailed usage procedures, see the StarBoard Software x.x Installation Guide or StarBoard Software User's Guide.

3. Using the StarBoard

3.1 Using the StarBoard

3.2 How to Use Touch Mode

3.3 How to Use the Electronic Pen

3. Using the StarBoard

3.1 Using the StarBoard

3.1.1 Starting Up the StarBoard

- (1) Press the power button at the lower left corner of the Digitiser to power up the plasma display.

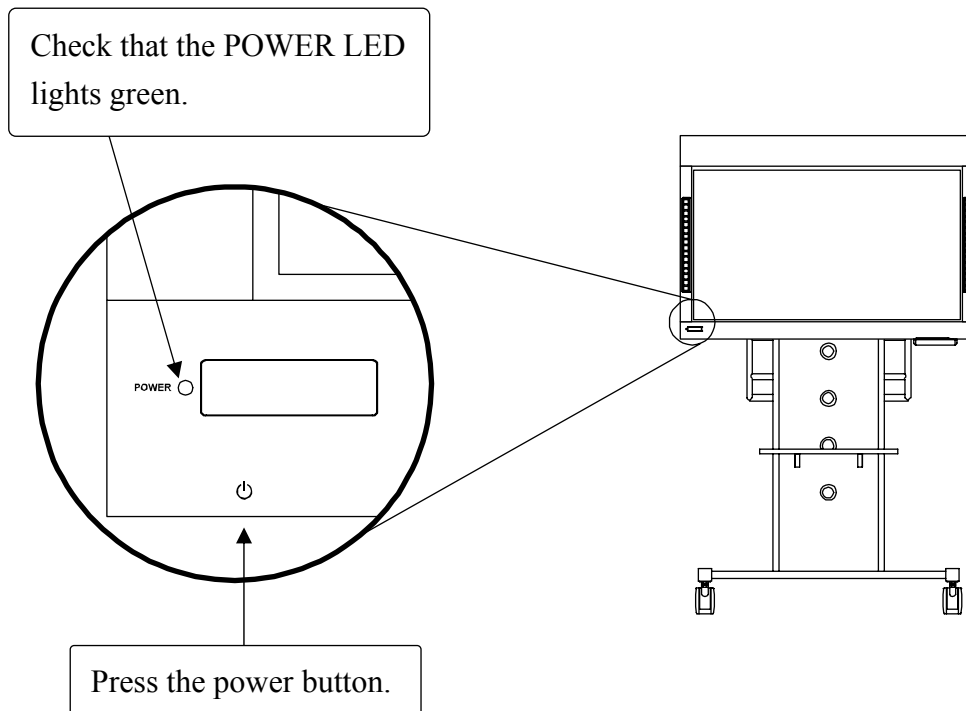

- (2) Turn on the PC connected to the StarBoard.
- (3) The StarBoard Software starts up automatically. (If [Startup] was not checked in the software installation procedure, the StarBoard Software will not start up even after Windows starts. In this case, manually start up the StarBoard Software.)

Manual Startup Procedure

Select [Start] → [Program] → [StarBoard Software] → [🖥️ StarBoard Software], or double-click the StarBoard Software icon on the desktop. (The StarBoard Software icon is not created on the desktop unless the [Desktop] checkbox was not checked in the software installation procedure.)

If the "No connection" icon in below appears on the Tasktray, it means that the StarBoard is not connected. Make sure that the StarBoard and the PC are properly connected.

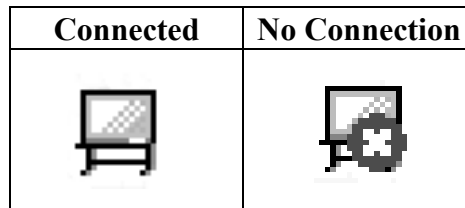

If the StarBoard is properly connected, the icon changes to "Connected" as above. If the icon does not change despite correcting the connection, there may be some other problem. For details, refer to "4. Appendix 4.1 Troubleshooting" on page 4-2 of this User's Guide.

If the cursor location deviates from the pen tip, perform calibration. In the StarBoard Software Main Menu, select "Settings" → "Calibration" → "OK". (Or "StarBoard" → "Settings" → "StarBoard" → "Calibration", when using Toolbar Mode.)

3.1.2 Shutting Down the StarBoard

- (1) Quit the StarBoard Software.
- (2) Quit Windows.
- (3) Turn off the PC connected to the StarBoard.
- (4) Press the power button at the lower left corner of the Digitiser to turn off the plasma display.

Check that the POWER LED goes off.

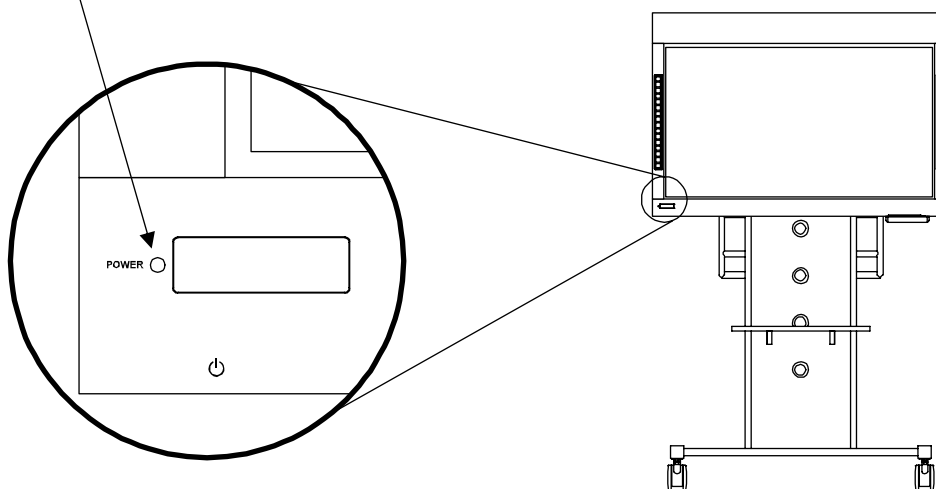

3.1.3 StarBoard Operation Procedure

(1) The StarBoard lets you write characters and figures on the PC screen displayed on the plasma display screen using the electronic pen. This is called "**Pen mode**". You can also operate the Windows screen and draw figures using your finger instead of the electronic pen. This is called "**Touch mode**".

Pen mode and touch mode are switched by the "Pen / Finger" button located on the Digitiser.

* The function buttons on the left and right sides cannot be operated at the same time.

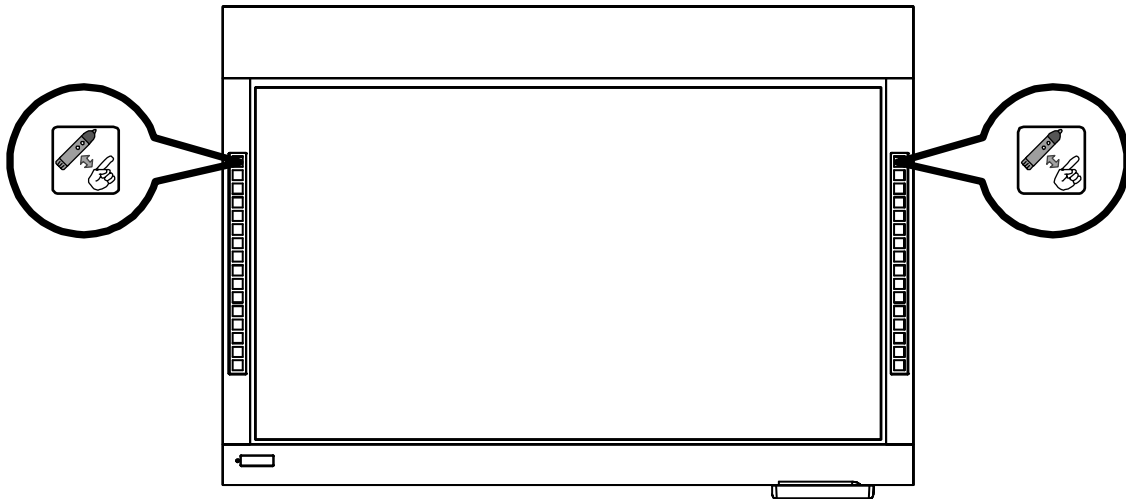

When the "Pen mode" icon in below appears on the Tasktray, you can perform operations using the electronic pen. At this time you can also move the mouse cursor using your finger, but you cannot perform clicking or other operations. Conversely, when the "Touch mode" icon in below appears on the Tasktray, you can perform operations with your finger. At this time, you can use the electronic pen, but the right-click and other functions assigned to the pen buttons do not work.

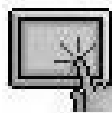
Pen mode	Touch mode
	

3.2 How to Use Touch Mode

This section gives a basic description of how to use the board in touch mode.

3.2.1 Character Input

To input characters, use your finger or the stylus that was provided with the product.

NOTICE

Use an input tool with a thickness of least 7 mm.

When inputting to this product, use a tool that is at least 7 mm. If a pen or similar tool with a thickness of less than 7 mm is used, the input will be unstable.

Also, do not use tools with a sharp tip, such as a ballpoint pen. If such a tool is used incorrectly, it could damage the surface of the board.

- Using the stylus pen and electronic pen.

Use the stylus pen on the board with your body kept sufficiently away, so that your palm and elbow do not touch the board. If your hand or elbow touches the board, or you are within 1 cm of the board, it might cause an incorrect operation.

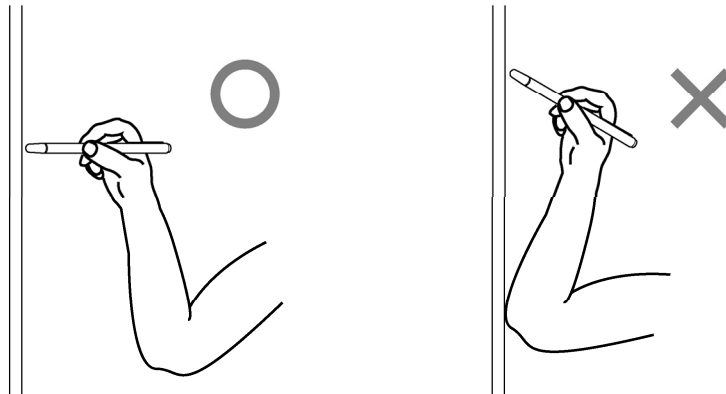

- Using your finger

Extend your finger and touch the board. In the same way as the stylus pen, if you touch the board with anything other than your finger or you are too close to the board, it might cause an incorrect operation.

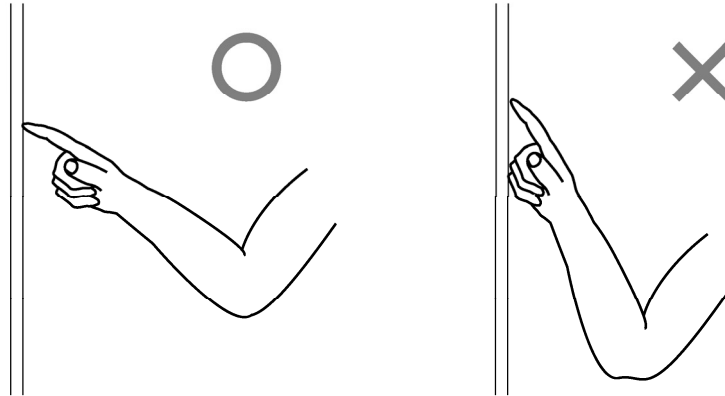

3.2.2 PC Operations

When performing PC operations by pointing or giving presentations without inputting characters, it is convenient to extend the stylus pen and use it as a pointer.

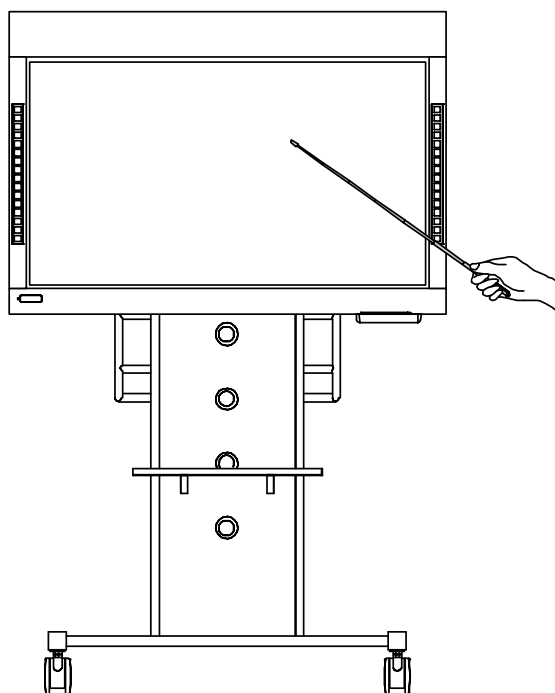

⚠ CAUTION

Do not strike the board forcefully with the stylus pen, bend it, or apply an excessive load to it.

Failure to comply may result in damage to the stylus pen or personal injury.

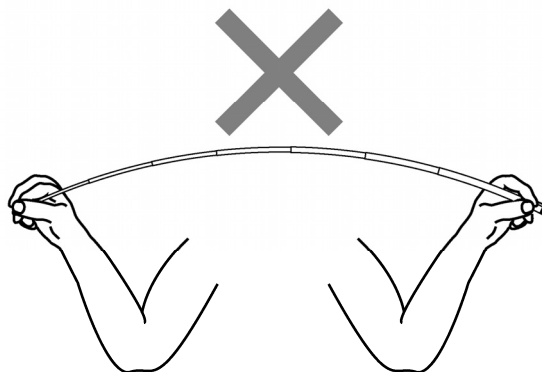

NOTICE

Keep the stylus pen in the pen tray when not in use.

If you leave it on the reflective tape, it might cause a sensor error or incorrect detection.

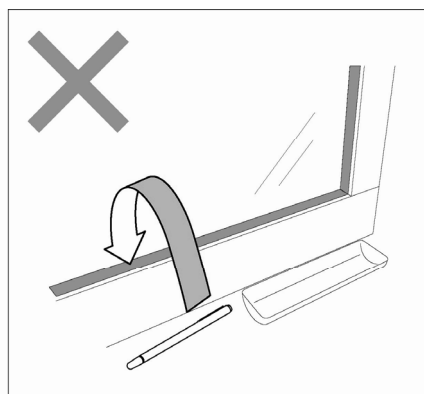
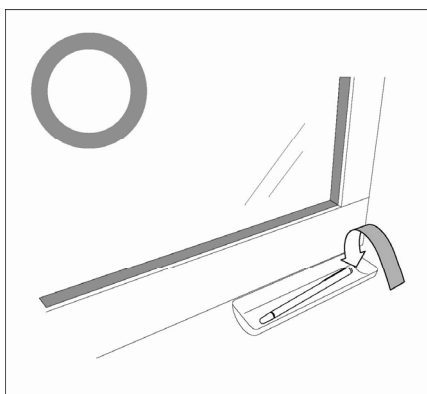

3.3 How to Use the Electronic Pen

3.3.1 Using the Electronic Pen

To use the electronic pen to draw characters or images, place the tip of the electronic pen on the board and then move the pen. When you release the tip of the electronic pen from the board, the writing is complete. Be careful of the following two points when using the electronic pen.

- (1) When drawing with the electronic pen, keep the pen as perpendicular as possible to the board and apply force sufficient enough to cause the pen tip to retract into the electronic pen.
- (2) A miniature transmitter is embedded in the tip of the electronic pen. If you hold the transmitter area of the electronic pen while drawing characters or images, the drawing data from the electronic pen might not be transmitted correctly. If the characters or images drawn on the whiteboard are not imported correctly into the PC, change your grip on the electronic pen and then verify that they are displayed correctly.

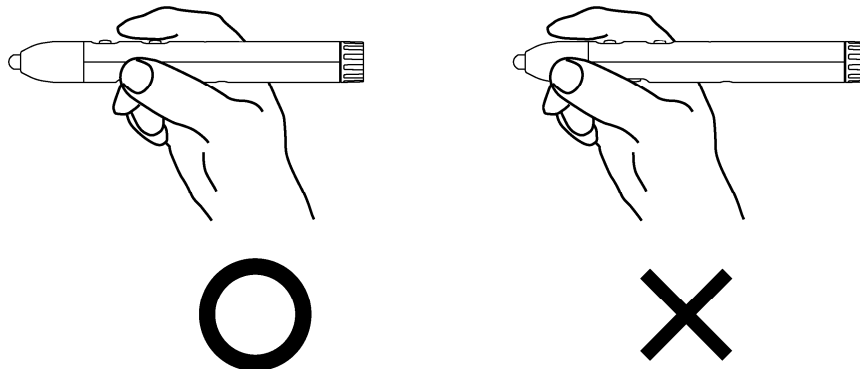

Blocking of the Infrared Beam

Electronic pen operations are detected when the digitiser reads the infrared beams that are generated by the pen. If the beam between the electronic pen and the digitiser is blocked, normal input becomes impossible. Avoid blocking them during use.

3.3.2 Electronic Pen Basic Operations

In the default setting of the electronic pen, the pen tip button is set to emulate the left click button of a mouse. While Windows is in operation, the following mouse operations can be performed using the pen tip button.

- Click

Push the pen tip onto the board with sufficient force and then quickly move the pen away from the board.

- Double click

Push the pen tip onto the board with sufficient force, and quickly move the pen away from the board two times in the same spot.

- Drag

Push the pen tip onto the board with sufficient force, and without releasing it away from the board, move it from one point to another.

3.3.3 Customising the Electronic Pen

The electronic pen has one pen tip button and three side buttons. Mouse actions can be assigned to these four buttons.

The default button settings are shown in the following table.

Button Name	Function
Pen tip	Left click
L (Side button No. 0)	Left double click
R (Side button No. 1)	Right click
C (Side button No. 2)	Hides/displays the StarBoard Software Toolbar

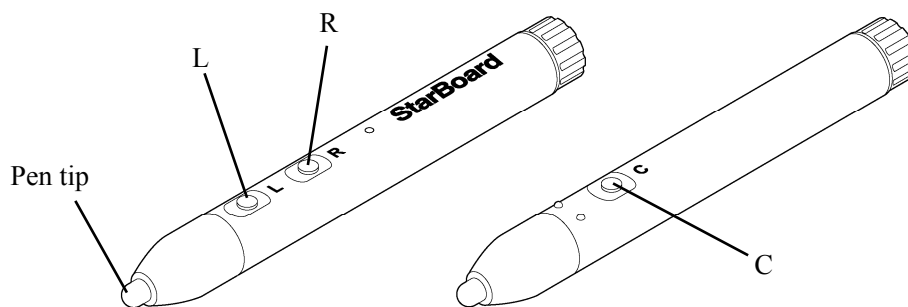

The side button settings can be changed. In the StarBoard Software Main Screen, select "Settings" → "Pen Settings" → "Configure Pen Buttons."

4. Appendix

4.1 Troubleshooting

4.2 Adjust the sensor (for Windows)

4.3 Regularly Auto Sensor Adjustment

4.4 Product Specifications

4.5 Proper Care and Cleaning

4.6 Replaceable Parts/ Limited Operating Life parts

4.7 Required components (Other vendor)

4.8 Provisions of Product Warranty

4. Appendix

4.1 Troubleshooting

Display-related problems

Problem	What to check	What to do
PC screen does not display on the Plasma Display.	Is the PC power on?	Power on the PC.
	Is the Plasma Display power on?	Power on the Plasma Display.
	Is the RGB cable connected to the PC and the Plasma Display properly?	Connect the RGB cable correctly. (For details on how to connect, refer the Plasma Display Operation Manual.)
	Do you select the connector to which the RGB cable is connected on the plasma display as the input signal?	Make sure that the connector to which the RGB cable is connected is the same as that selected as the input signal.
	For laptop PCs, is external (RGB) output selected?	Connect cable after starting up the PC, or switch to external (RGB) output at the screen display mode setting. (Method of switching differs by PC. For instructions, refer the PC manual and other documentation.)
	Was the Plasma Display switching done right (may be assigned to a function key)?	Set so the Plasma Display and monitor are both selected, or that just the monitor is selected. (For details on selection, refer the PC manual and other documentation.)
	Other than the above	Refer to the Plasma Display Operation manual. Then if you cannot solve the problem, contact a support centre.
The PC screen displayed on the plasma display is distorted.	Does the resolution of the PC match the resolution supported by the plasma display?	Change the resolution of the PC screen to the resolution supported by the plasma display. (For details, refer to the Plasma Display Operation Manual.) Once the resolution has been adjusted properly, make sure to calibrate the pen position before use.
	Does the refresh rate of the PC match the refresh rate supported by the plasma display?	Adjust the refresh rate of the PC screen to match the refresh rate supported by the plasma display. (Some PCs do not allow the refresh rate to be set. For details, refer to the PC manual.)
	Other than the above	Refer to the "Troubleshooting" in the Plasma Display Operation manual. Then if you cannot solve the problem, contact a support centre.

Recognition-Related Problems

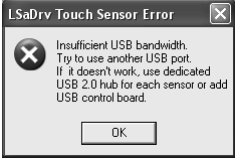
Problem	What to check	What to do
The StarBoard does not recognise input.	Is the USB cable connected to the PC?	Connect the USB cable to the PC.
	When viewing the central region of the digitiser (page 1-5) from the bottom, is the LED lit green?	Check the USB cable connection.
	Did you start the system in the correct sequence?	Start the system in the correct sequence. (For details on starting the system, see page 3-1 of this User's Guide.)
	StarBoard Software files may be broken or installation may not be complete correctly.	Uninstall the StarBoard Software and then re-install it. (For details on installing StarBoard Software, see the StarBoard Software x.x User's Guide.)
	Other than the above	Contact a support centre.
The following Touch Sensor Error appears.	Is something blocking light from reaching the board surface or reflective tape?	Remove the blockage.
	Is the reflective tape dirty?	Wipe away any soiling on the reflective tape.
	Other than the above	Adjust the sensor. (See page 4-4 of this User's Guide.)
The following Touch Sensor Error appears.	The controller must be reset and the system restarted.	Disconnect the USB cable and reconnect it. If this does not solve the problem, restart the PC.
The following Touch Sensor Error appears.	Is a high-speed USB device connected to the USB host controller used to connect the StarBoard?	Be sure to connect the StarBoard and any high-speed USB devices to separate USB host controllers.
		Be sure to use a USB hub in the case of PCs with only one USB host controller.
		

Input-Related Problems

Problem	What to check	What to do
The input position does not match.	Has position alignment been performed properly?	Perform proper position alignment.
	Other than the above	Contact a support centre.
The electronic pen does not work.	This may be due to faulty contact of electronic pen batteries.	Remove the batteries from the electronic pen and re-install them.
	Are batteries used up?	Replace the batteries. (For details on battery replacement, see page 2-7 of this User's Guide.)
	StarBoard Software files may be broken or installation may not be complete correctly.	Uninstall the StarBoard Software and then re-install it. (For details on installing StarBoard Software, see the StarBoard Software x.x User's Guide.)
	Is there a infrared light source close to the digitiser? (Illumination from fluorescent lighting or similar source)	Check by turning off the lights in the room. If the StarBoard operates normally, change the location in which it is installed or change the lighting fixtures.
	Other than the above	Restart Windows and StarBoard Software. Contact a support centre. Check if the same problem arises when using another electronic pen. If operations are normal when using another electronic pen, the original pen is the problem.
Electronic pen operation is unstable or stops.	Is a remote controller for AV equipment being operated while using the pen?	Stop operating the remote controller.
	The battery charge of the electronic pen may be low.	Replace the batteries. (For details on battery replacement, see page 2-7 of this User's Guide.)
	StarBoard Software files may be broken or installation may not be complete correctly.	Uninstall the StarBoard Software and then re-install it. (For details on installing StarBoard Software, see the StarBoard Software x.x User's Guide.)
	Other than the above	Restart Windows and StarBoard Software. Check if the same problem arises when using another electronic pen. If operations are normal when using another electronic pen, the original pen is the problem.

4.2 Adjust the sensor (for Windows)

4.2.1 Items to Check Before Making Sensor Adjustments

The following error may appear while using this product.



Check the following items if this error appears.

- Check that light is not blocked from reaching the board surface or reflective tape.
- Check that the reflective tape is not dirty.

If the problem is not corrected despite making the above checks, perform adjustments according to the steps given in item 4.2.2, "Sensor Adjustment Procedure."

4.2.2 Sensor Adjustment Procedure

- [1] Press the "Adjust Camera" button on the "LSaDrv Touch Sensor Error" dialog box displayed on the PC screen.

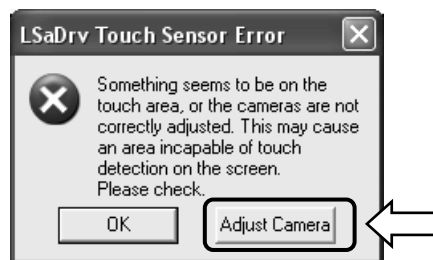

Manual Startup

To start the sensor adjustment wizard manually, execute "LsCamWiz.exe" found in "C:\Program Files\Hitachi Software Engineering\FX-DuoDriver."

[2] "Camera Adjustment Wizard Start" window appears. Press "All Adjust."

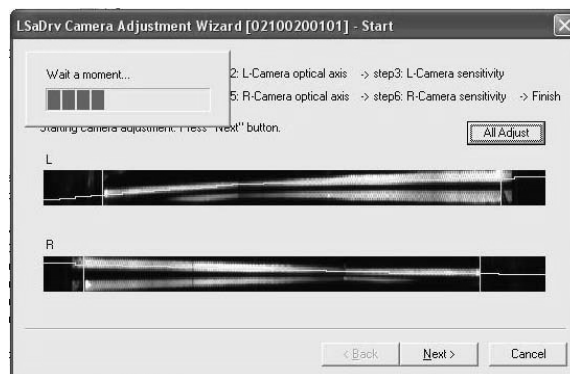
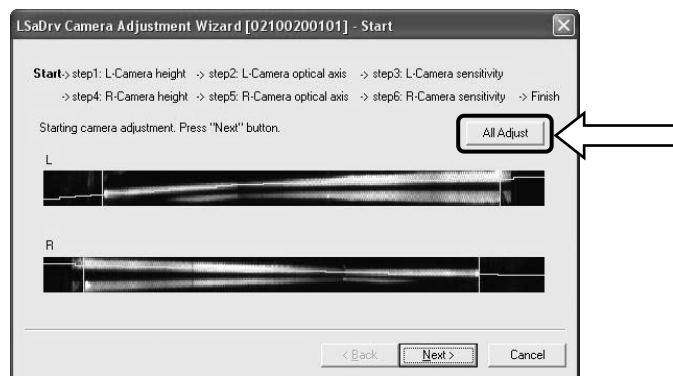

[3] Press "Finish."



This completes sensor adjustment.

After making adjustments, check that input can be performed normally.

4.3 Regularly Auto Sensor Adjustment

While using StarBoard, auto sensor adjustment will execute regularly. To use StarBoard comfortably this function is recommended to use.

4.3.1 Sensor Auto Adjustment Procedure

[1] Confirmation message of auto sensor adjustment will be displayed after 7days passed from first connect of StarBoard to PC. If you press “OK”, auto sensor adjustment program will execute. If you press “NO”, this will not execute.

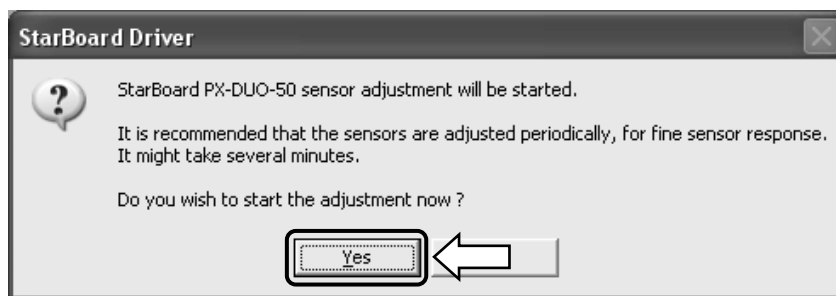

Manual execute

* Switch to PC Operation before Sensor Adjustment (Press the function button ).
For the manual execute, select “StarBoard” – “Setting” – “StarBoard” – “Pen Settings” and press “Sensor adjustment” in the StarBoard toolbar.

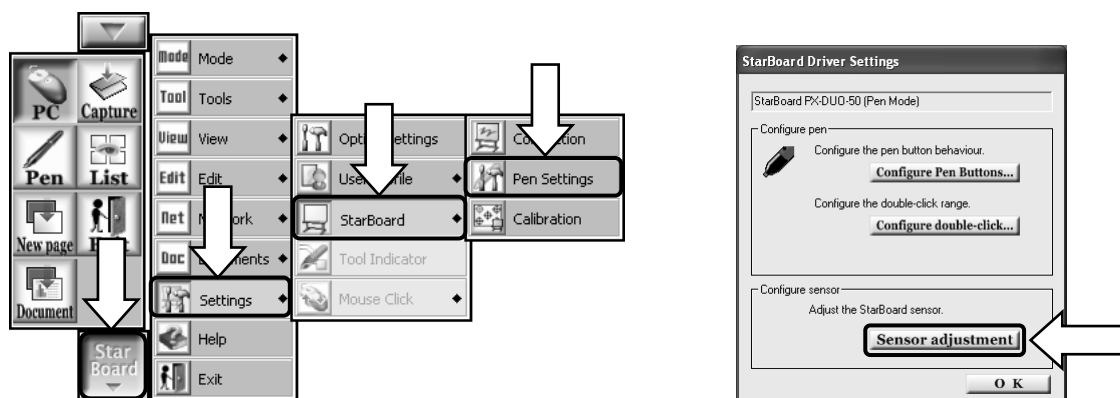

[2] Sensor adjusting screen will be displayed during auto adjustment. Do not touch the board surface until auto adjustment completed.

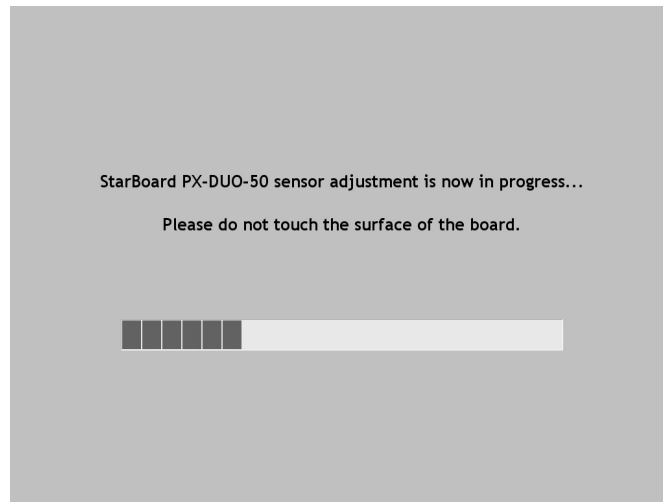

[3] Following window will be displayed when sensor auto adjustment finished. Press "OK".



This is all of auto sensor adjustment.
Confirm the normal input after adjustment.

* In case of adjustment error, following window will be displayed. Press "Retry" to auto sensor adjustment program execute again.



If this message displayed again, StarBoard may have some problem. Please Contact our support.

4.4 Product Specifications

4.4.1 PX-DUO-50P/65P Digitiser Specifications

Item	Specification	
Model name	PX-DUO-50P* ⁴	PX-DUO-65P
Model No.	AH00235	AH00232
Detection method	Infrared image sensor system* ¹	
Digitiser resolution	Approx. 0.05mm	
Sampling rate	Approx. 100 points/second (when using USB 1.1 Full Speed)	
Interface	USB 1.1 (cable length: 6.4 m)	USB 1.1 (cable length: 6.2 m)
Effective detection area	1122(W) × 645 (H) mm	1461(W) × 835 (H) mm
Power consumption	5V 500mA (USB Bus Power)	
External dimensions	1220(W) × 845(H) × 66(D) mm	1556(W) × 1041(H) × 66(D) mm
Weight	Approx. 7.5 kg	Approx. 9.5 kg
Paint colour	Dark gray	
Operating requirements	+5°C – 35°C (Humidity: 20 – 80% RH, without condensation)	
Storage requirements	-10°C – +45°C (Humidity: 20 – 80% RH, without condensation)	
Electronic pen	Communication system: Infrared (Carrier wavelength: 56 kHz, IR wavelength: 940 nm)* ² Side switches: 3 Power supply: AAA Expected battery life: Approx. 80 hours of continuous use* ³ (alkaline battery) Size: 149 mm × φ17 mm Weight: Approx. 20 g (not including batteries)	
Standards, etc.	VCCI Class B, FCC Class B, CE	

*1 Using infrared and compact cameras, this product captures the image (shadow) of a pen or finger and detects the corresponding coordinate position. Do not operate near lighting that will obstruct the capture of the image. This includes:

- Locations where direct sunlight strikes the board surface or comes from the side.
 - Locations with white incandescent lighting or strong infrared source directly overhead.
- Depending on installation conditions or sensor property, position detection may be off by about 9 mm.

*2 The electronic pen uses infrared light having the same frequency (approx. 940 nm). Do not operate this product in a location where other equipment (fluorescent lighting, plasma displays, passive sensors, etc.) may emit a similar frequency.

*3 The expected battery lifetime may vary depending on initial battery conditions, humidity, and the operating environment.

*4 "AH00246: Additional Function Button" is included in the PX-DUO-50P configuration.

4.4.2 Plasma Specifications

Refer to the Plasma Display Operation Manual for the plasma display hardware specifications.

4.5 Proper Care and Cleaning

Clean the StarBoard periodically so that you may use it for a long time to come.

 CAUTION
Before cleaning StarBoard, be sure to disconnect the power cable and the USB cable.
Electric shock or damage to the product will result.

(1) Cleaning the StarBoard

- To clean the StarBoard, use a soft cloth dampened with a diluted neutral cleansing agent that does not contain a polishing compound.
- Note that rubbing or striking the StarBoard and Plasma display surface with a finger nail or other hard object may result in scratching.

(2) Cleaning the reflective tape

If the reflective tape is dirty, it will affect pen or finger operations. Clean the reflective tape periodically or whenever it becomes dirty or soiled.

- To clean the reflective tape, apply a minimal amount of diluted neutral cleansing agent that does not contain a polishing compound to a soft cloth and wipe.
- Never use a solvent such as thinner.
- Use a soft cloth so that the surface of the reflective tape does not become scratched.

(3) Cleaning the electronic pen

- To clean the electronic pen, use a diluted neutral cleansing agent that does not contain a polishing compound. Do not apply the neutral cleansing agent directly, but rather dampen a soft wet cloth with a mixture of water and the cleaner, and wipe. Never use a solvent such as thinner.
- Do not allow the pen tip to get wet.

4.6 Replaceable Parts/Limited Operating Life parts

4.6.1 Replaceable Parts

- (1) Stylus pen
- (2) AAA alkaline Battery
- (3) Spare pen tip

4.6.2 Limited lifespan

- (1) Plasma display panel (Depends on PDP maker's specification.)
- (2) Digitiser (Approx. 5 years)

For details on obtaining them, contact your dealer or a support centre.

4.7 Required components (Other vendor)

4.7.1 Plasma display / Dedicated setup unit

Securely attach the StarBoard using a Plasma display and Dedicated setup unit.

PX-DUO-50P

- Plasma display (Panasonic: TH-50PH10, TH-50PH11, TH-50PH12)
(Panasonic: TH-50PF10, TH-50PF11)
- Mobile Stand (Hayami Industry Co., Ltd: PH-857-11)
- Wall mounting unit (Panasonic: TY-WK42PV7)

PX-DUO-65P

- Plasma display (Panasonic: TH-65PF10, TH-65PF11, TH-65PF12)
- Mobile Stand (Hayami Industry Co., Ltd: PH-960)
- Mobile Stand (Kyoei Shoji, Co., Ltd: APS-L1500)
- Wall mounting unit (Panasonic: TY-WK65PV7)

Always use a setup unit specified by Hitachi. When using the wall mounting unit, the mounting work must be performed by a specialist. For details on obtaining them, contact your dealer or a support centre.

4.7.2 Dedicated Speakers

A separately sold dedicated speaker is available for the StarBoard.

PX-DUO-50P

- Dedicated Speakers (Panasonic: TY-SP50P8W-K)

PX-DUO-65P

- Dedicated Speakers (Panasonic: TY-SP65P10WK)

Before use, thoroughly read the instruction manual included with the speaker to ensure correct connections.

4.8 Provisions of Product Warranty

1. During the free warranty service period, if a malfunction occurs during normal use, the malfunction will be corrected without charge, according to the provisions of the warranty. Furthermore, if the customer registration card accompanying the warranty is not returned to our company, the customer information will not be registered; so free repairs might be unavailable. After receiving this product, please immediately fill out and return this customer registration card.

2. The warranty coverage is as listed in the following table:

Product Name	Part Name	Warranty Coverage
StarBoard	PX-DUO-50P/65P Digitiser	+
	Electronic pen	+
	USB cable	+
	RGB cable	+
AAA alkaline Battery		-
Spare pen tips		-
Other Parts and Options		-

(Explanatory note): + → Covered by warranty (excluding wear and physical damage)

- → Not covered by warranty

About the warranty of Plasma Display, refer to the Plasma Display Operation Manual.

3. Please refer to the warranty sheet for this product's warranty service period.

4. Even during the warranty period, there will be a repair charge in the following cases:

- (1) If the registration card accompanying the warranty is not returned to our company.
- (2) If the warranty is not presented.
- (3) If specified fields on the registration card accompanying the warranty are not completed, or if the wording has been changed without authorization.
- (4) The warranty applies only to the original purchasers. (It does not apply to a third party to whom the customer resold this product.)
- (5) In the event of a malfunction or damage resulting from the customer's improper handling (e.g., a fall, impact, etc., caused by the customer during transportation or movement).
- (6) In the event of problems resulting from handling contrary to the handling and precautions mentioned in this user's guide.
- (7) In the event of failure or damage resulting from abnormal voltages, pollution or other natural disasters (e.g., fire, earthquake, and lightning).

-
- (8) In the event of a malfunction in this product caused by the connection to this product of equipment other than the equipment specified by our company.
 - (9) In the event that there is no abnormality in this product, but a defect in a part other than this product was detected or remedied.
 - (10) In the event of ordinary wear and tear, wear, deterioration, etc., of consumables, even during normal use.
5. If this product malfunctions, review the contents of this user's guide. If the problems remain irreparable, contact the dealer. the dealer will determine whether or not the product must be repaired, so please contact them. If the customer sends the product to our company without RMA (Return Merchandise Authorization) number, it might not be covered by warranty.
6. As a rule, the customer is responsible for shipping charges required to send all or part of the product for repair, etc. Our company will assume responsibility for the return shipping to the customer.
7. This warranty does not cover labour fees for repair-associated equipment assembly or disassembly.
8. Incidental damage caused by the failure of this product (e.g., loss of profit that should have resulted from the use of this product) is outside the scope of this warranty.
9. The aforementioned provisions define this warranty, and they supersede those of all express or implied warranties that include legal defect liability.
10. This warranty is limited to use of this product within the country where the user bought this product.