

CRP-22 CRP-26

Classroom Projector

Quick Reference Guide

Use this book as a reference guide when setting up the projector. For detailed information about installation, setup, and operation of the projector, refer to the owner's manual on the CD-ROM.

READ THE SAFETY INSTRUCTIONS IN THE OWNER'S MANUAL (CD-ROM) BEFORE USING THE PROJECTOR.

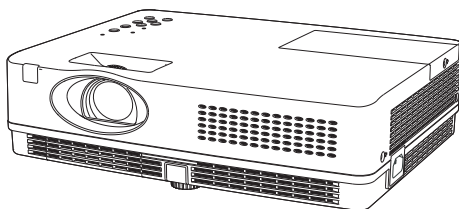
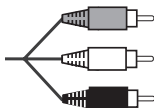
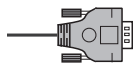
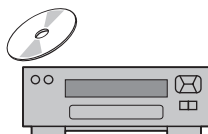
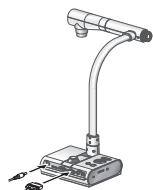

English

Deutsch

Français

Español

Italiano

Português

Installing the Projector in Proper Position

Install the projector properly. Improper Installation may reduce the lamp life and cause a fire hazard.

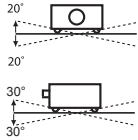

Do not tilt the projector more than 20 degrees from side to side.

Do not pitch the projector more than 30 degrees above and below.



Do not point the projector up to project an image.



Do not point the projector down to project an image.



Do not put the projector on either side to project an image.

Moving the Projector

When moving the projector, replace the lens cap and retract adjustable feet to prevent damage to the lens and cabinet.

When the projector is not in use for an extended period, put it into a suitable case with the lens side up.



Safety Precaution

Allowing the proper amount of space on the top, sides, and rear of the projector cabinet is critical for proper air circulation and cooling of the unit. The dimension shown here indicate the minimum space required. If the projector is to be built into a compartment or similarly enclosed, these minimum distances must be maintained.

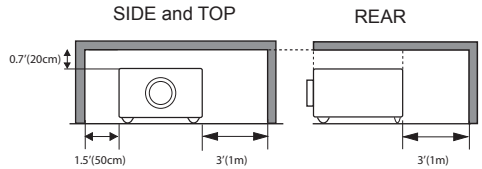

Connecting the AC Power Cord

This projector uses nominal input voltages of 100–120 V or 200–240 V AC and it automatically selects the correct input voltage.



CAUTION

The AC outlet must be near this equipment and must be easily accessible.

✓ **Note:**

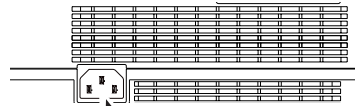

Unplug the AC power cord when the projector is not in use. When this projector is connected to an outlet with the AC power cord, it is in Stand-by mode and consumes a little electric power.



Connect the AC power cord (supplied) to the projector.

NOTE ON THE POWER CORD

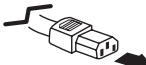
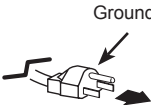
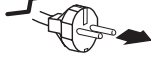
AC power cord must meet requirement of the country where you use the projector. Confirm the AC plug type with the chart below and proper AC power cord must be used. If supplied AC power cord does not match your AC outlet, contact your sales dealer.

| Projector side | AC outlet side | | |
|---|--|--|--|
| | For the U.S.A. and Canada | For Continental Europe | For the U.K. |
|  <p>To power cord connector on your projector.</p> |  <p>Ground</p> <p>To the AC outlet. (120 V AC)</p> |  <p>To the AC outlet. (200 - 240 V AC)</p> |  <p>To the AC outlet. (200 - 240 V AC)</p> |

Front

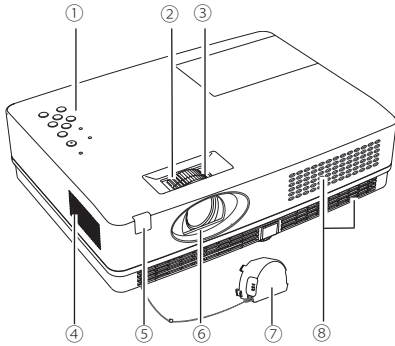

- ① Top controls and Indicators
- ② Zoom Ring
- ③ Focus Ring
- ④ Speaker
- ⑤ Infrared Remote Receiver
- ⑥ Projection Lens
- ⑦ Lens Cap



CAUTION

Do not turn on a projector with lens cap attached. High temperature from light beam may damage lens cap and result in fire hazard.

- ⑧ Air Intake Vent

Back

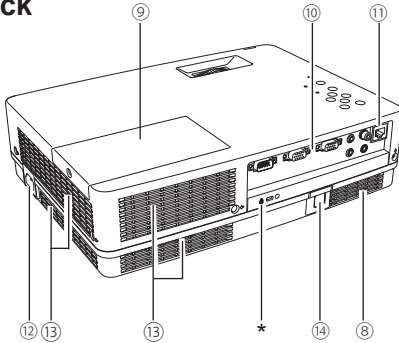

- ⑨ Lamp Cover
- ⑩ Terminals and Connectors
- ⑪ LAN Connection Terminal
- ⑫ Power Cord Connector
- ⑬ Exhaust Vents



CAUTION

Hot air is exhausted from the exhaust vent. Do not put heat-sensitive objects near this side.

- ⑭ Filters
- ⑮ Adjustable Foot

Bottom

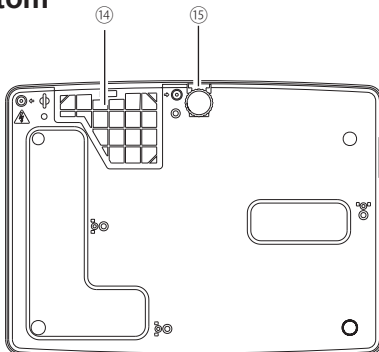

✓Note:

⑬ LAN Connection Terminal is for the Network function. Refer to the owner's manual of "Network Set-up and Operation".

* Kensington Security Slot

This slot is for a Kensington lock used to deter theft of the projector.

* Kensington is a registered trademark of ACCO Brands Corporation.

Rear Terminal

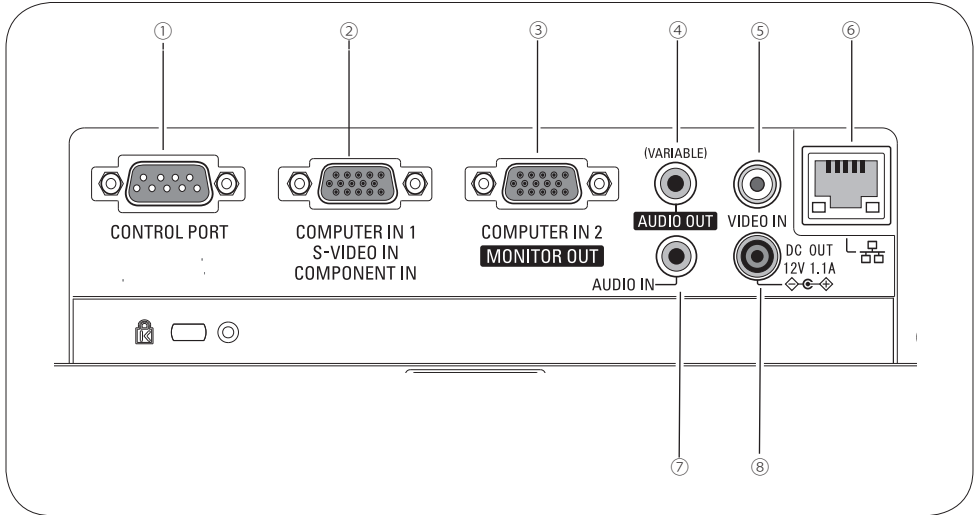

- ① **CONTROL PORT**
When the projector is controlled by a computer, connect to this jack with serial control cable.
 - ② **COMPUTER IN 1 /S-VIDEO IN / COMPONENT IN**
Connect analog RGB output signal from a computer, S-VIDEO output signal from video equipment, or RGB scart 21-pin video output or component video output to this terminal.
 - ③ **COMPUTER IN 2 / MONITOR OUT**
 - Connect analog RGB output signal from a computer to this terminal.
 - This terminal can be used to output the incoming analog RGB and Component signal from COMPUTER IN 1 /S-VIDEO IN /COMPONENT IN terminal to the other monitor.
 - ④ **AUDIO OUT (VARIABLE)**
Connect an external audio amplifier to this jack.
This terminal outputs sound from AUDIO IN terminal.
 - ⑤ **VIDEO IN**
Connect the composite video output signal to this jack.
 - ⑥ **LAN Connection Terminal**
Connect the LAN cable (refer to the owner’s manual of “Network Set-up and Operation”).
 - ⑦ **AUDIO IN**
Connect the audio output signal from computer or video equipment to this jack.
 - ⑧ **DC OUT 12V 1.1A**
Connect the DC power cord (supplied) to this jack to supply DC 12V to a document camera.
- Notes on using ELMO document cameras;**
- The projector can supply 12V DC power to the document camera "L-1ex/TT-02RX" or "L-1n/TT-02s" with setting to Network mode of Standby mode menu.
 - Do not connect any other document cameras other than ELMO "L-1ex/TT-02RX" and "L-1n/TT-02s" with the supplied VGA/DC power combined cord. Otherwise damages may result.
 - Use only the supplied VGA/DC power combined cord.
 - When DC OUT 12V jack is plugged in, the cooling fans are running even if the projector is in standby mode.

Top Panel

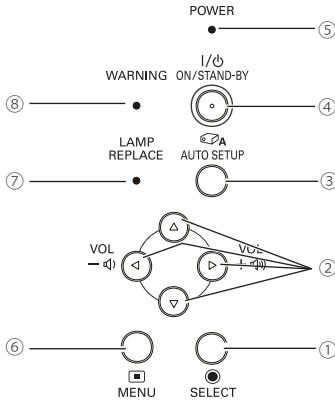

- ① **SELECT button**
 - Execute the selected item.
 - Expand or compress the image in the Digital zoom mode.
- ② **POINT ▲▼◀▶ (VOLUME +/-) buttons**
 - Select an item or adjust the value in the On-Screen Menu.
 - Pan the image in the Digital zoom +/- mode.
 - Adjust the volume level (Point ◀▶ buttons).

- ③ **AUTO SETUP button**
 - Execute the setting of Auto setup (includes Input search, Auto PC adj. and Auto Keystone functions) in the setting menu.

- ④ **ON/STAND-BY button**
 - Turn the projector on or off.

- ⑤ **POWER indicator**
 - Lights red when the projector is in stand-by mode.
 - Lights green during operations.
 - Blinks green in the Power management mode.

- ⑥ **MENU button**
 - Open or close the On-Screen Menu.

- ⑦ **LAMP REPLACE indicator**
 - Lights yellow when the projection lamp reaches its end of life.

- ⑧ **WARNING indicator**
 - Lights red when the projector detects an abnormal condition.
 - Blinks red when the internal temperature of the projector exceeds the operating range.

Remote Control Battery Installation

- 1 Open the battery compartment lid.

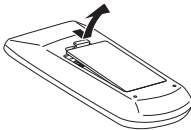

- 2 Install new batteries into the compartment.

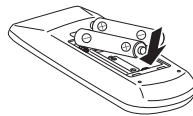

Two AAA size batteries
For correct polarity (+ and –), be sure battery terminals are in contact with pins in compartment.

- 3 Replace the compartment lid.

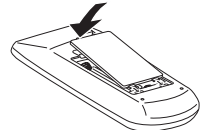

To ensure safe operation, please observe the following precautions :

- Use two (2) AAA or LR03 type alkaline batteries.
- Always replace batteries in sets.
- Do not use a new battery with a used battery.
- Avoid contact with water or liquid.
- Do not expose the remote control to moisture or heat.
- Do not drop the remote control.
- If the battery has leaked on the remote control, carefully wipe the case clean and install new batteries.
- Risk of an explosion if battery is replaced by an incorrect type.
- Dispose of used batteries according to the instructions or your local disposal rule or guidelines.

Remote Control Operating Range

Point the remote control toward the projector (Infrared Remote Receiver) when pressing the buttons. Maximum operating range for the remote control is about 16.4'(5 m) and 60 degrees in front of the projector.

Adjustable Foot

Projection angle can be adjusted up to 10.0 degrees with the adjustable foot.

Lift the front of the projector and push the foot lock latch on the projector.

Release the foot lock latch to lock the adjustable foot and rotate the adjustable foot to adjust the position and tilt.

To retract the adjustable foot, lift the front of the projector and push and undo the foot lock latch.

Keystone distortion of the projected image can be corrected by menu operation.

Remote Control

✓Note:

To ensure safe operation, please observe the following precautions:

- Do not bend, drop, or expose the remote control to moisture or heat.
- For cleaning, use a soft dry cloth. Do not apply benzene, thinner, spray, or any chemical material.

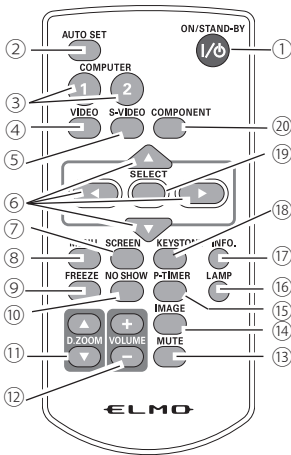

- ① **ON/STAND-BY button**
Turn the projector on or off.
You can also turn the document camera on or off with this button.
- ② **AUTO SET button**
Correct vertical keystone distortion and adjust computer display parameters such as **Fine sync.**, **Total dots**, and **Picture position**.
- ③ **COMPUTER 1/2 buttons**
Select the COMPUTER 1 or COMPUTER 2 input source.
- ④ **VIDEO button**
Select the VIDEO input source.
- ⑤ **S-VIDEO button**
Select the S-VIDEO input source.
- ⑥ **Point ▲▼◀▶ buttons**
 - Select an item or adjust the value in the On-Screen Menu.
 - Pan the image in the Digital zoom +/- mode.
- ⑦ **SCREEN button**
Select a screen mode.
- ⑧ **MENU button**
Open or close the On-Screen Menu.
- ⑨ **FREEZE button**
Freeze the picture on the screen.
- ⑩ **NO SHOW button**
Temporarily turn off the image on the screen.
- ⑪ **D.ZOOM ▲▼ buttons**
Zoom in and out the images.

To be continued on the next page.

⑫ **VOLUME +/- buttons**
Adjust the volume level.

⑬ **MUTE button**
Mute the sound.

⑭ **IMAGE button**
Select the image mode.

⑮ **P-TIMER button**
Operate the P-timer function.

⑯ **LAMP button**
Select a lamp mode.

⑰ **INFO. button**
Operate the information function.

⑱ **KEYSTONE button**
Correct keystone distortion.

⑲ **SELECT button**
– Execute the selected item.
– Expand or compress the image in Digital zoom mode.

⑳ **COMPONENT button**
Select the COMPONENT input source.

Positioning the Projector

For projector positioning, see the figures below. The projector should be set perpendicularly to the plane of the screen.

✓ **Note:**

- The brightness in the room has a great influence on picture quality. It is recommended to limit ambient lighting in order to obtain the best image.
- All measurements are approximate and may vary from the actual sizes.

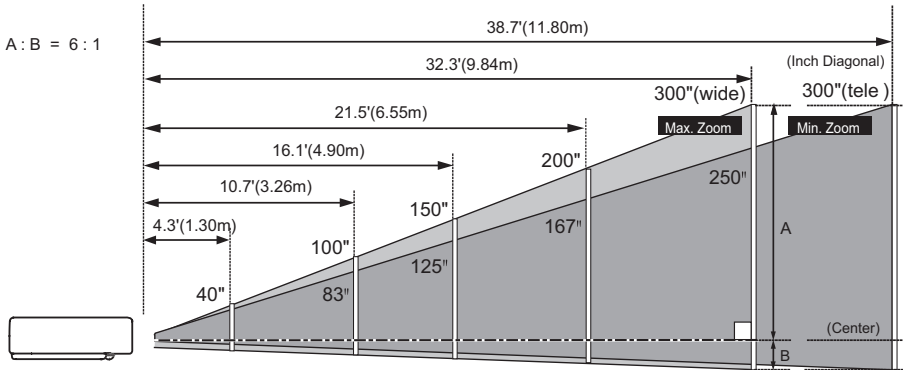

| Screen Size (W x H) mm 4 : 3 aspect ratio | 40" | 100" | 150" | 200" | 300" |
|---|-------------|--------------|--------------|--------------|---------------|
| | | 813 x 610 | 2032 x 1524 | 3048 x 2286 | 4064 x 3048 |
| Zoom (max) | 4.3'(1.30m) | 10.7'(3.26m) | 16.1'(4.90m) | 21.5'(6.55m) | 32.3'(9.84m) |
| Zoom (min) | 5.1'(1.55m) | 12.9'(3.92m) | 19.4'(5.90m) | 25.8'(7.87m) | 38.7'(11.80m) |

Connecting to a Computer

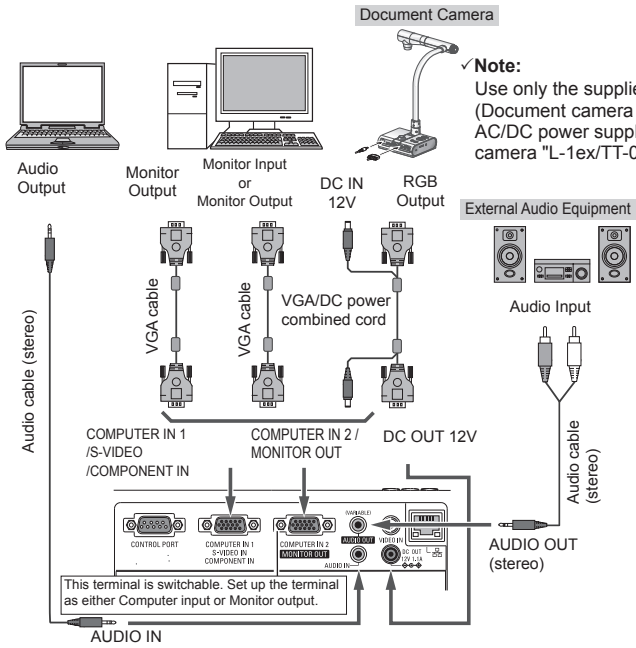

Document Camera

Note:
Use only the supplied VGA/DC power combined cord.
(Document camera can be powered separately by AC/DC power supply came with the ELMO document camera "L-1ex/TT-02RX" or "L-1n/TT-02s".)

Cables used for connection

- VGA Cables (Mini D-sub 15 pin)
- VGA/DC power combined cord (supplied)
- Audio Cables

Note:

- Input sound to the AUDIO IN terminal when using the COMPUTER IN 1 /S-VIDEO IN / COMPONENT IN and the COMPUTER IN 2/MONITOR OUT terminals as input.
- When the AUDIO OUT is plugged-in, the projector's built-in speaker is not available.
- When the cable is of the longer variety, it is advisable to use the COMPUTER IN 1 /S-VIDEO IN / COMPONENT IN and not the COMPUTER IN 2/MONITOR OUT.

Connecting to Video Equipment

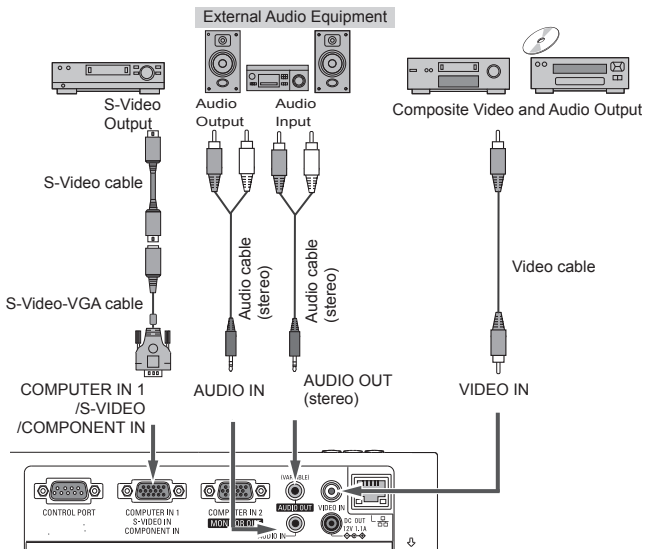

Cables used for connection

- Video Cable
- S-Video Cable
- S-Video-VGA Cable
- Audio Cables (Mini Plug: stereo)

(Cables are not supplied with the projector.)

Note:
When the AUDIO OUT is plugged-in, the projector's built-in speaker is not available.

Connecting to Component Video Equipment

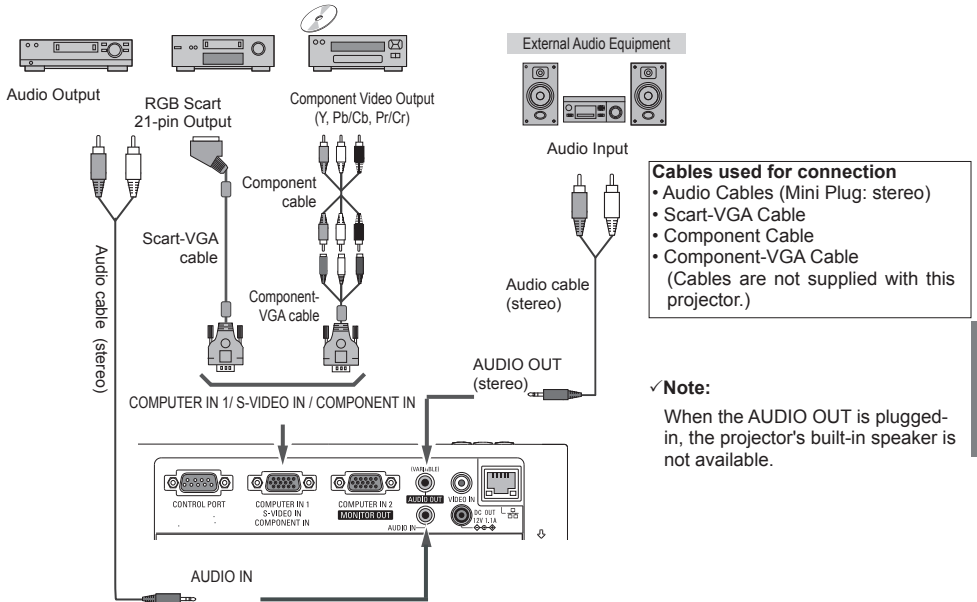

Turning On the Projector

- 1 Complete peripheral connections (with a computer, VCR, etc.) before turning on the projector.
- 2 Connect the projector's AC power cord into an AC outlet. The POWER indicator lights red. Open the lens cap.
- 3 Press the ON/STAND-BY button on the top control or on the remote control. The POWER indicator lights green and the cooling fans start to operate. The preparation display appears on the screen and the count down starts.
- 4 After the countdown, the input source that was selected the last time and the lamp control status icon appear on the screen.
- 5 If there is no signal input when start on the projector, or the current signal is missed while operating the projector, the Video/PC selection window will be displayed on the screen, please move the pointer to input source desired by pressing the Point ▲▼ buttons and press the SELECT button. And then follow the input signal guidance window to correct the signal and connection. If the projector is locked with a PIN code, PIN code input dialog box will appear. Enter the PIN code as instructed on the next page.

Note:

- The projector can be turned ON or OFF by pressing the POWER button on the remote control of the specified document camera ("L-1ex/TT-02RX" or "L-1n/TT-02s").
- The projector can be turned off with this remote by pressing once; however, the "Power Off?" indicator on the screen will not be displayed.
- While the POWER indicator is blinking, the lamp is being cooled down and the projector cannot be turned back on.

Note:

- When the Logo select function is set to **Off**, the logo will not be shown on the screen.
- If the PIN code number is not entered within three minutes after the PIN code dialog box appeared, the projector will be turned off automatically.
- The "1234" is set as the initial PIN code at the factory.

What is PIN code?

PIN (Personal Identification Number) code is a security code that allows the person who knows it to operate the projector. Setting a PIN code prevents unauthorized use of the projector.

Enter a PIN code

Use the Point ▲▼ buttons to enter a number. Press the Point ◀▶ buttons to fix the number and move the red frame pointer to the next box. The number changes to *. If you fixed an incorrect number, use the Point ◀▶ buttons to move the pointer to the number you want to correct, and then enter the correct number.

Repeat this step to complete entering a four-digit number.

After entering the four-digit number, move the pointer to **Set**. Press the SELECT button so that you can start to operate the projector.

If you entered an incorrect PIN code, **PIN code** and the number (****) will turn red for a moment. Enter the correct PIN code all over again.

Turning Off the Projector

- 1 Press the ON/STAND-BY button on the top control or on the remote control, and **Power off?** appears on the screen.
- 2 Press the ON/STAND-BY button again to turn off the projector. The POWER indicator starts to blink red, and the cooling fans keep running. (You can select the level of fans' quietness and speed. At this time, you can unplug the AC power cord even if the fans are still running.)
- 3 When the projector has cooled down enough, the POWER indicator stops blinking and you can turn on the projector.

✓ **Note:**

Do not put the projector in a case before the projector is cooled enough.

How to Operate the On-Screen Menu

The projector can be adjusted or set via the On-Screen Menu. For each adjustment and setting procedure, refer to the respective sections in this manual.

- 1 Press the MENU button on the top control or the remote control to display the On-Screen Menu.
- 2 Use the Point ▲▼ buttons to highlight or select a main menu item. Press the Point ▶ or the SELECT button to access the submenu items. (The selected item is highlighted in orange.)
- 3 Use the Point ▲▼ buttons to select the desired submenu item and press the SELECT button to set or access the selected item.
- 4 Use the Point ▲▼◀▶ buttons to adjust the setting or switch between each option and press the SELECT button to activate it and return to the submenu.
- 5 Press the Point ◀ button to return to the main menu; press the MENU button again to exit the On-Screen Menu.

On-Screen Menu

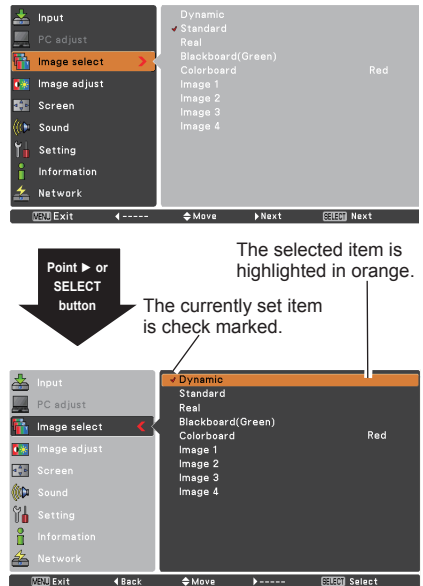

Technical Specifications

Mechanical Information

| | |
|------------------------|---|
| Projector Type | Classroom Projector |
| Dimensions (W x H x D) | 13.13" x 3.35" x 9.72" (333.5mm x 85.2mm x 247.0mm) (Not including protrusions) |
| Net Weight | 5.5 lbs (2.5 kg) |
| Foot Adjustment | 0° to 10° |

Panel Resolution

| | |
|------------------|--|
| LCD Panel System | 0.55" TFT Active Matrix type, 3 panels |
| Panel Resolution | 1,024 x 768 dots |
| Number of Pixels | 2,359,296 (1,024 x 768 x 3 panels) |

Signal Compatibility

| | |
|--------------------|--|
| Color System | PAL, SECAM, NTSC, NTSC4.43, PAL-M, and PAL-N |
| SD/HDTV Signal | 480i, 480p, 575i, 575p, 720p, 1035i, and 1080i |
| Scanning Frequency | H-sync. 15 kHz–100 kHz, V-sync. 50–100 Hz |

Optical Information

| | |
|----------------------------------|---|
| Projection Image Size (Diagonal) | Adjustable from 40" to 300" |
| Throw Distance | 4.3' - 38.7' (1.30m - 11.80m) |
| Projection Lens | F 2.0 ~ 2.15 lens with f 18.38 mm ~ 22.06 mm with manual zoom and focus |
| Projection Lamp | 220 W |

Interface

| | |
|---|-----------------------------------|
| Video Input Jack | RCA Type x 1 |
| Audio Input Jack | Mini Jack (stereo) x 1 |
| Computer In 1 / S-video In / Component Input Terminal | Mini D-sub 15 pin x 1 |
| Computer In 2 / Monitor Out Terminal | Mini D-sub 15 pin x 1 |
| Control port | D-sub 9 pin x 1 |
| Audio Output Jack | Mini Jack (stereo) x 1 (variable) |
| LAN Connection Terminal | RJ45 |
| DC Output Jack | DC 12V, 1.1A |

Audio

| | |
|--------------------|-------------------------|
| Internal Audio Amp | 1.0 W RMS |
| Built-in Speaker | 1 speaker, ø1.1" (28mm) |

Power

Voltage and Power Consumption

CRP-22:

AC 100–120 V (3.3A Max. Ampere), 50/60 Hz (The U.S.A and Canada)
AC 200–240 V (1.8A Max. Ampere), 50/60 Hz (Continental Europe and The U.K.)

CRP-26:

AC 100–120 V (3.5A Max. Ampere), 50/60 Hz (The U.S.A and Canada)
AC 200–240 V (1.9A Max. Ampere), 50/60 Hz (Continental Europe and The U.K.)

Operating Environment

| | |
|-----------------------|--------------------------|
| Operating Temperature | 41°F–95°F (5 °C–35 °C) |
| Storage Temperature | 14°F–140°F (-10°C–60 °C) |

Remote Control

| | |
|-----------------|---|
| Battery | AAA or LR03 1.5V ALKALINE TYPE x 2 |
| Operating Range | 16.4' (5 m)±30° |
| Dimensions | 2.0" (W) x 0.7" (H) x 4.3" (D) (52 mm x 18 mm x 110 mm) |
| Net Weight | 2.37 oz (67 g) (including batteries) |

Accessories

| | |
|---------------------------------------|------------------------------|
| Owner's Manual (CD-ROM) | Network Application (CD-ROM) |
| Quick Reference Guide & Safety Manual | Ferrite core |
| AC Power Cord | |
| Remote Control and Batteries | |
| VGA/DC power combined cord | |
| Lens Cap with String | |
| PIN Code Label | |